

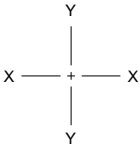

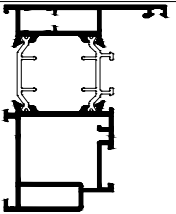

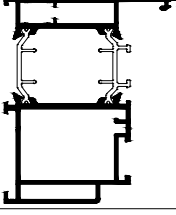

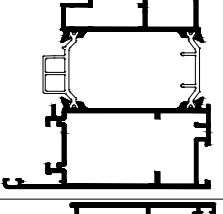

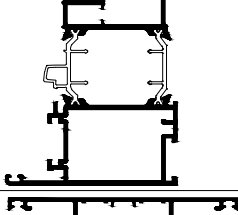
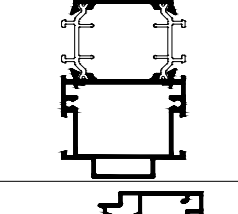
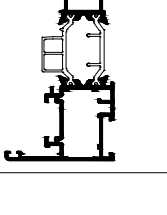

# *PE85Ntt BUILDING*





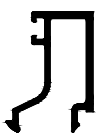

PROFILNI

Kod Codice Code	Presjek Sezione Cross Section		Težina	Perimetar	Vidljiva	Jx	Wx	Jy	Wy
			Peso Weight	Perimetro Perimeter	površina Sup. in Vista Exposed surface				
			Kg/m	mm	mm	cm <sup>4</sup>	cm <sup>4</sup>	cm <sup>4</sup>	cm <sup>4</sup>
PE85202			0841						
				1.860	331.1	133.1	58.51	12.25	20.48
PE85206			0839						
				1.967	345.1	147.1	65.19	13.72	29.49
PE85242			0843						
				1.967	345.1	147.1	65.19	13.72	29.49
PE85214			0842						
				2.195	496.5	142.4	64.94	16.32	51.34
PE85235			0847						
				2.010	363.5	140.0	66.14	15.32	35.64
PE85139			0845						
				2.141	386.7	114.5	24.72	6.50	19.11
PE85241			0820						
				1.607	370.5	114.5	49.8	11.5	12.5
PE85241			0806						
				0.988	370.5	91.17	1.15	1.0	16.56
			0625						
			0850						
			0851						

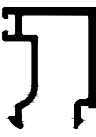
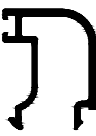

PROFILI

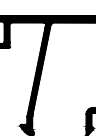
Kod Codice Code	Presjek Sezione Cross Section	Težina Peso Weight Kg/m	Perimetar Perimetro Perimeter mm	Vidljiva površina Sup. in Vista Exposed surface mm	Jx cm <sup>4</sup>	Wx cm <sup>4</sup>	Jy cm <sup>4</sup>	Wy cm <sup>4</sup>
PR50553		0.258	151.12	31.1				
PR50554		0.260	151.84	32.1				
PR50555		0.248	146.01	28.8				
PR50556		0.266	154.02	35.1				
PR50557		0.255	148.35	31.88				
PR50558		0.271	155.47	37.1				
PR50559		0.259	149.81	33.88				
PR50560		0.275	156.92	39.1				



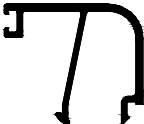
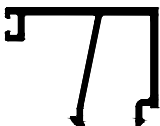
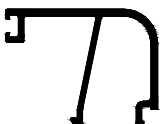
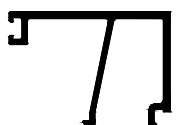
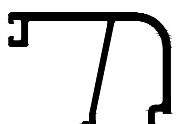

PROFILI

Kod Codice Code	Presjek Sezione Cross Section	Težina Peso Weight Kg/m	Perimetar Perimetro Perimeter mm	Vidljiva površina Sup. in Vista Exposed surface mm	Jx cm <sup>4</sup>	Wx cm <sup>4</sup>	Jy cm <sup>4</sup>	Wy cm <sup>4</sup>
PR50561		0.263	151.26	35.88				
PR50562		0.298	170.22	42.1				
PR50563		0.287	164.55	38.88				
PR50564		0.306	173.09	45.1				
PR50565		0.294	167.42	41.88				
PR50566		0.322	182.16	47.1				
PR50567		0.301	176.49	43.88				
PR50568		0.342	192.16	52.1				

PROFILI

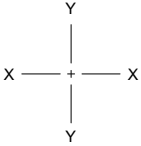
Kod Codice Code	Presjek Sezione Cross Section	Težina Peso Weight Kg/m	Perimetar Perimetro Perimeter mm	Vidljiva površina Sup. in Vista Exposed surface mm	Jx cm <sup>4</sup>	Wx cm <sup>4</sup>	Jy cm <sup>4</sup>	Wy cm <sup>4</sup>
PR50569		0.330	176.49	48.88				
PR50570		0.354	198.16	55.1				
PR50571		0.341	192.49	51.88				
PR50572		0.362	202.16	57.1				
PR50573		0.350	196.49	53.88				
PR50574		0.211	104.50	26.60				
PR50576		0.218	103.56	27.10				

PROFILI

Kod Codice Code	Presjek Sezione Cross Section		Težina Peso Weight  Kg/m	Perimetar Perimetro Perimeter  mm	Vidljiva površina Sup. in Vista Exposed surface mm	Jx  cm <sup>4</sup>	Wx  cm <sup>4</sup>	Jy  cm <sup>4</sup>	Wy  cm <sup>4</sup>
PR50550			0.158	49.06	14.5				
PR58538			0.206	105.3	20.9				
PR58543			0.211	80.3	28.0				

PROFILI OKVIRA

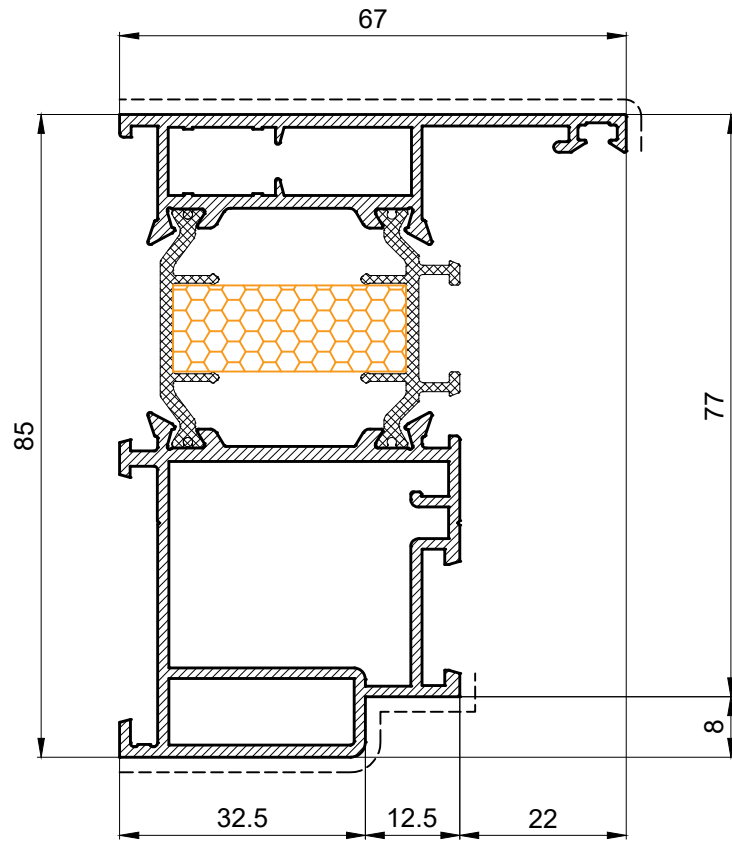

PE85202 1.860 Kg/m

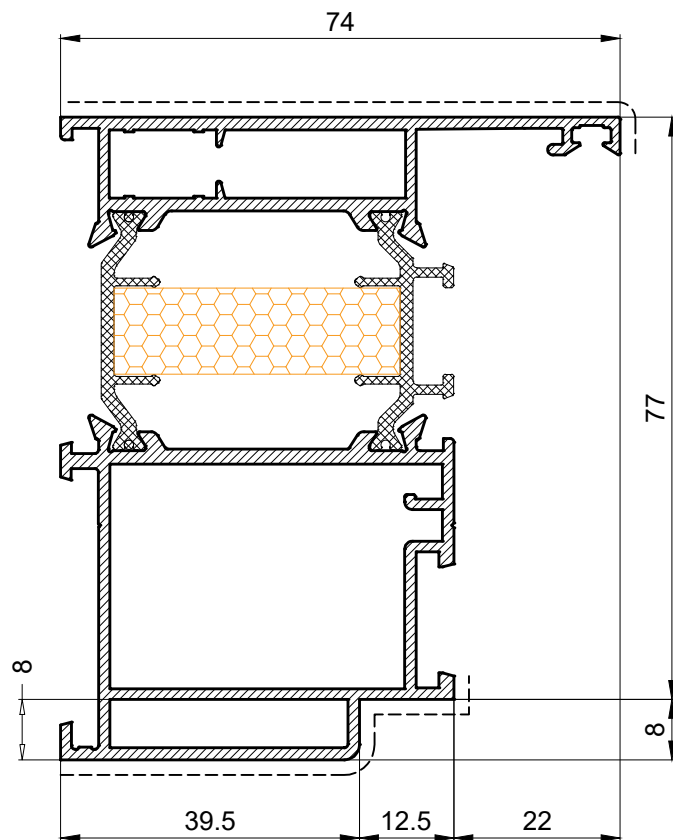

PE85206 1.967 Kg/m

PROFILI KRILA

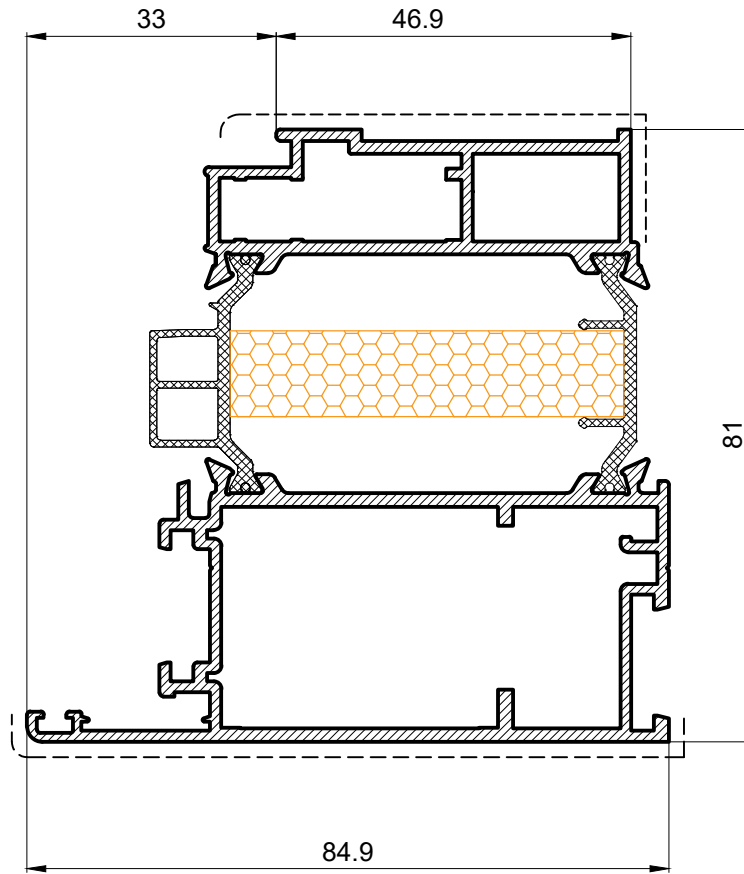

PE85242 2.195 Kg/m

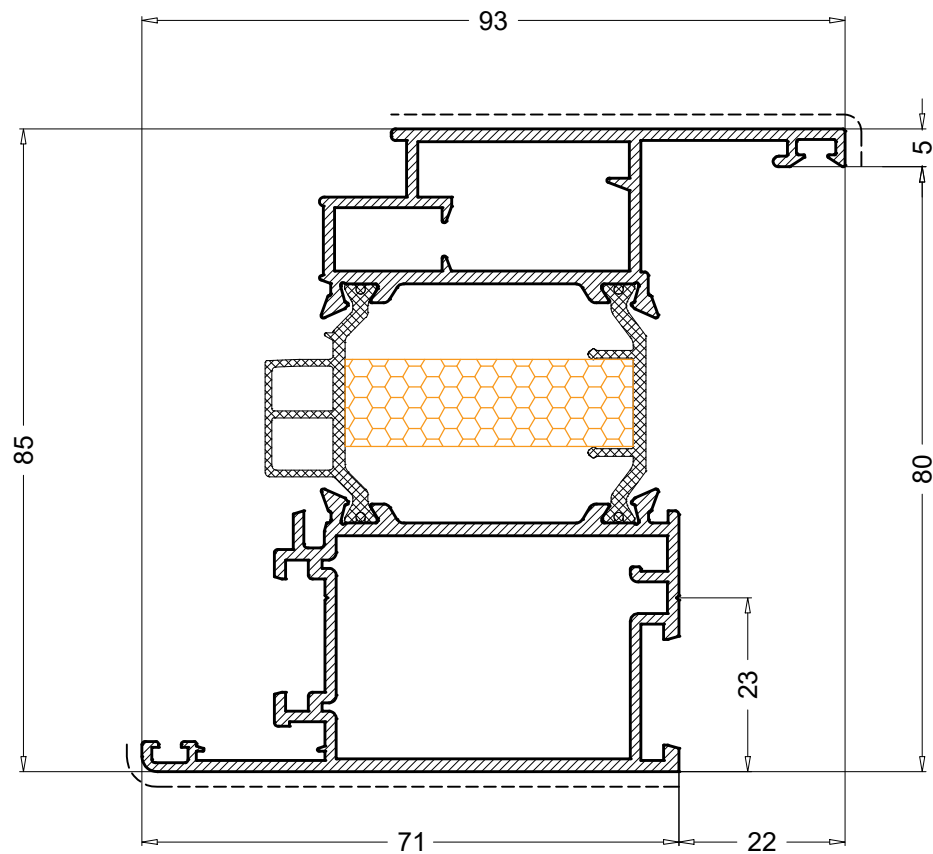

PE85214 2.046 Kg/m



PROFILI KRILA

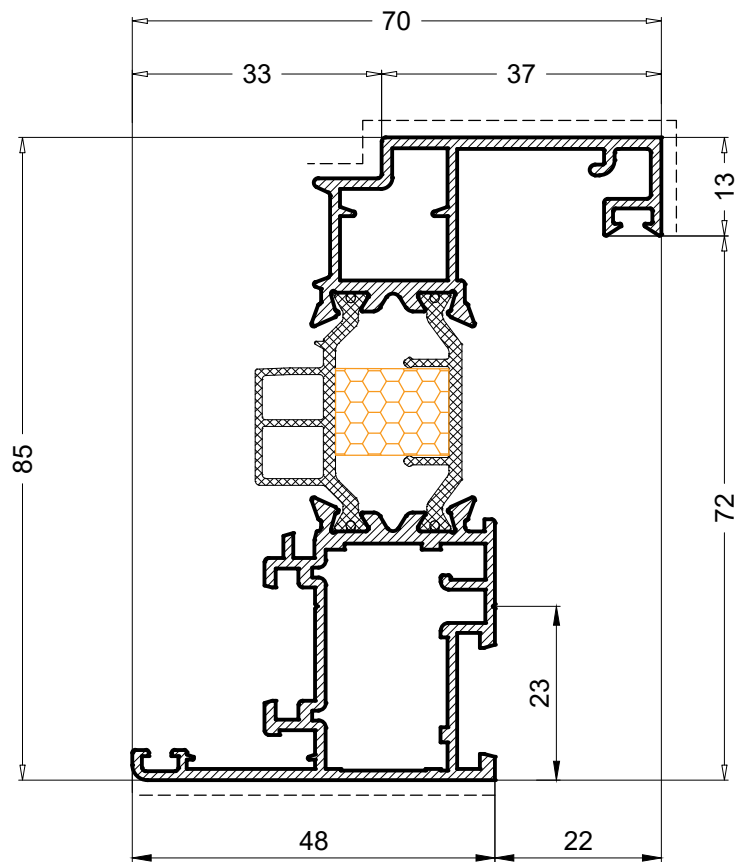

PE85139 1.607 Kg/m

PROFILI PREČKE I PRAGA

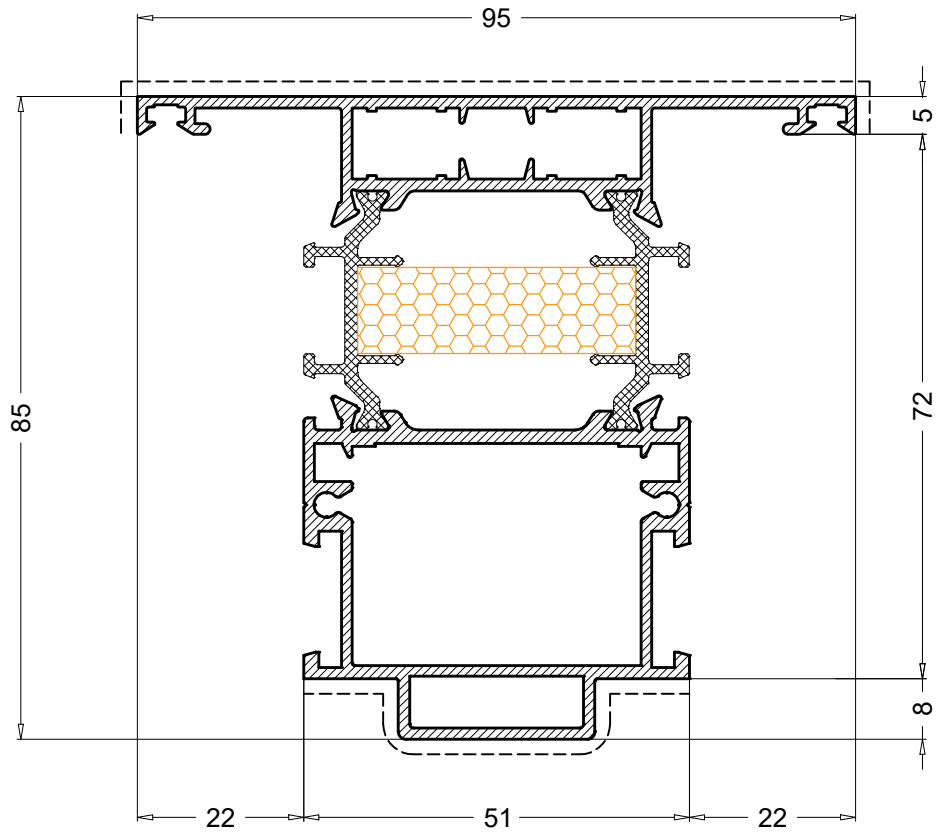

PE85235 2.142 Kg/m

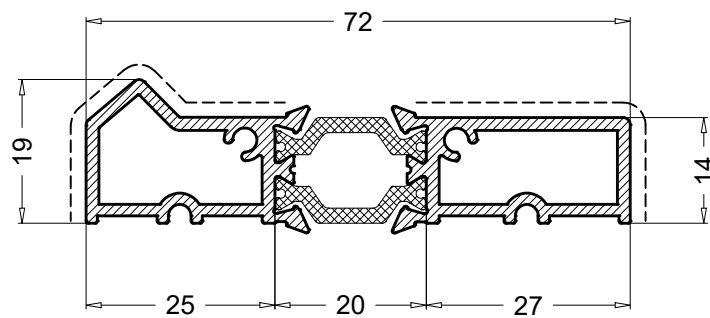

PE85241 0.988 Kg/m

DODATNI PROFILI

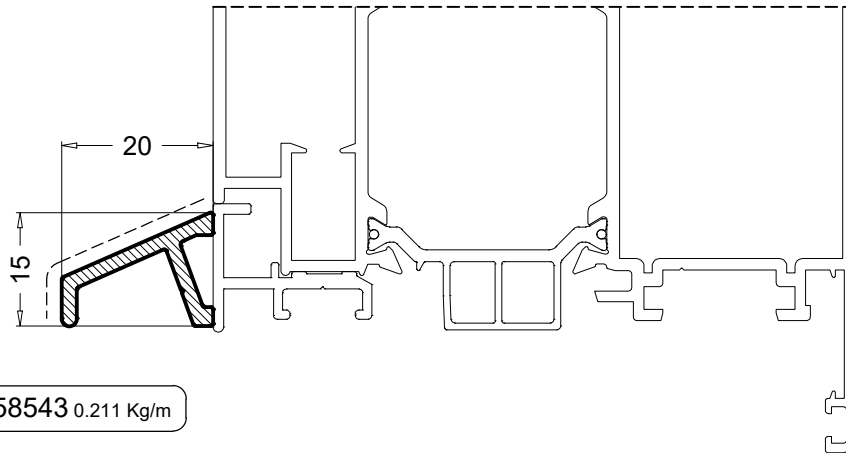

PR58543 0.211 Kg/m

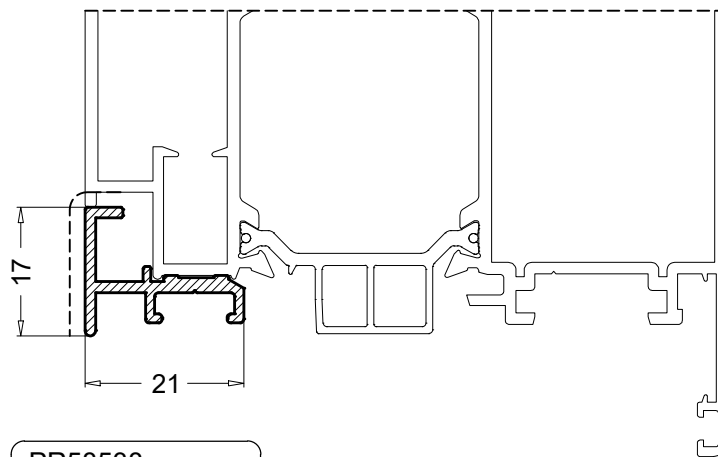

PR58538 0.206 Kg/m

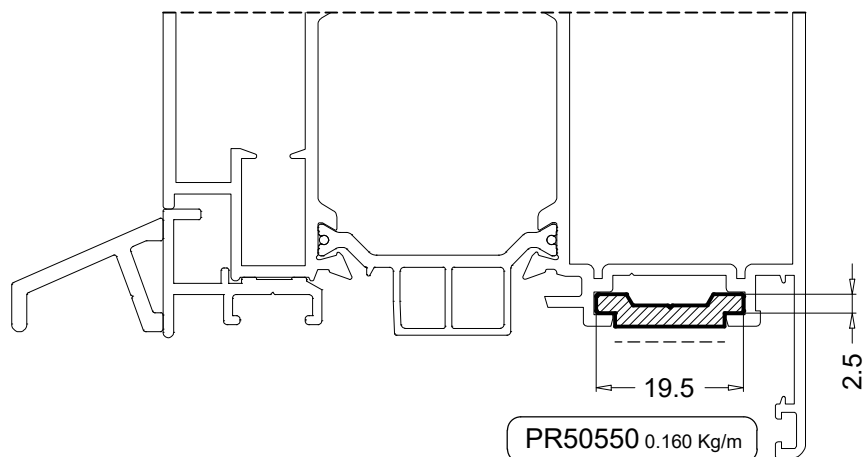

PR50550 0.160 Kg/m

# PROFILI LAJSNE

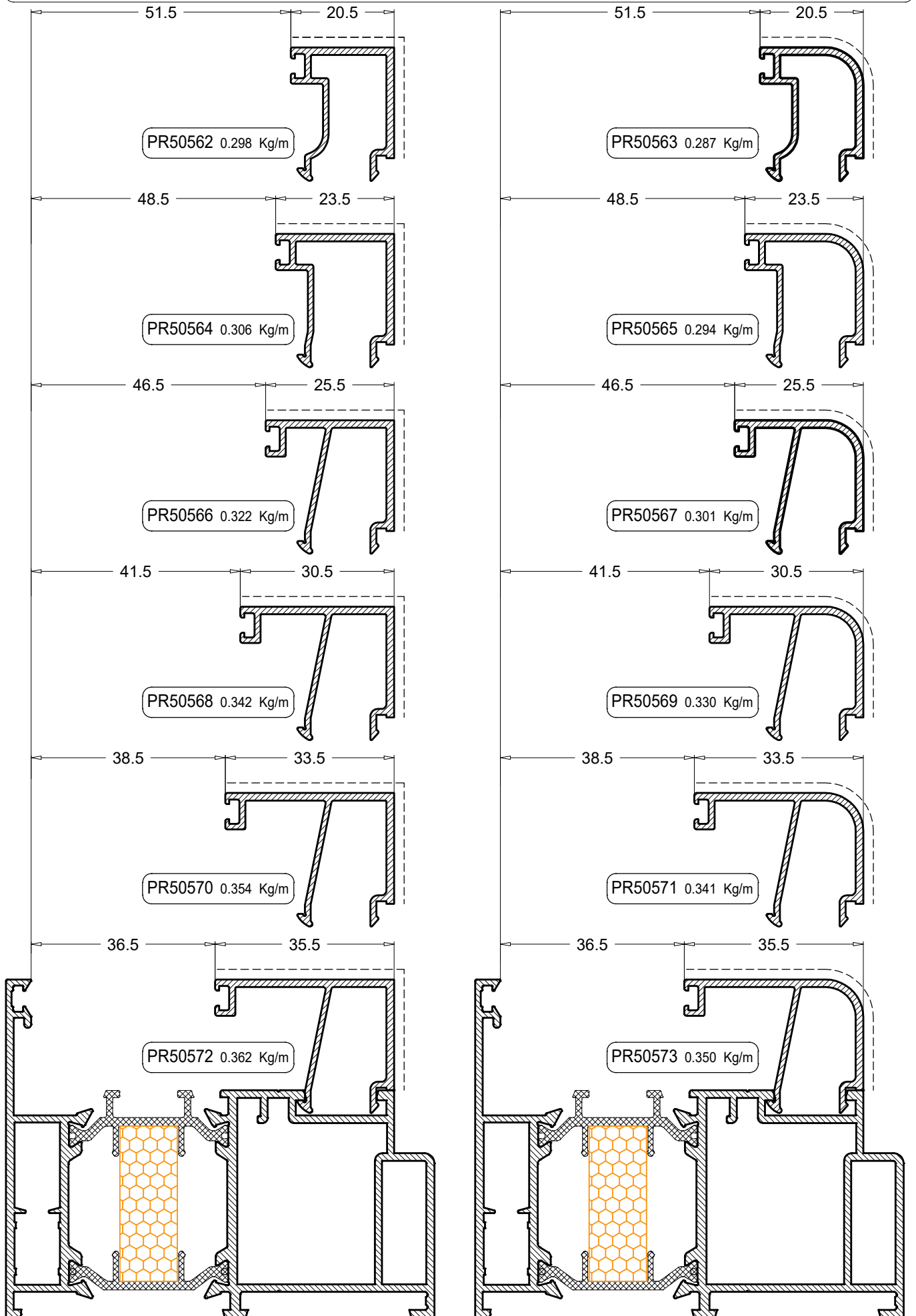

**PROFILI LAJSNE**

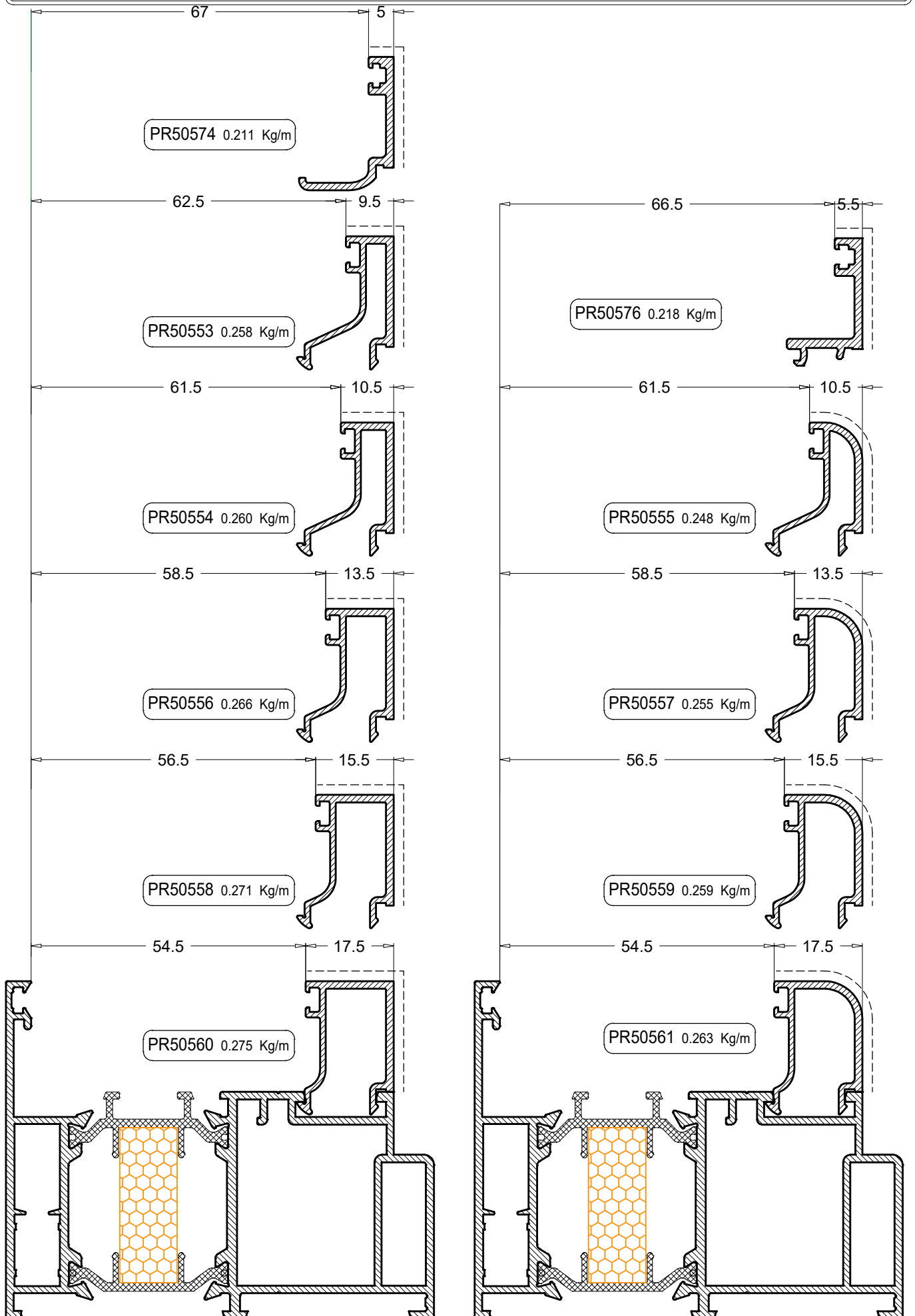

### PROFILI LAJSNE

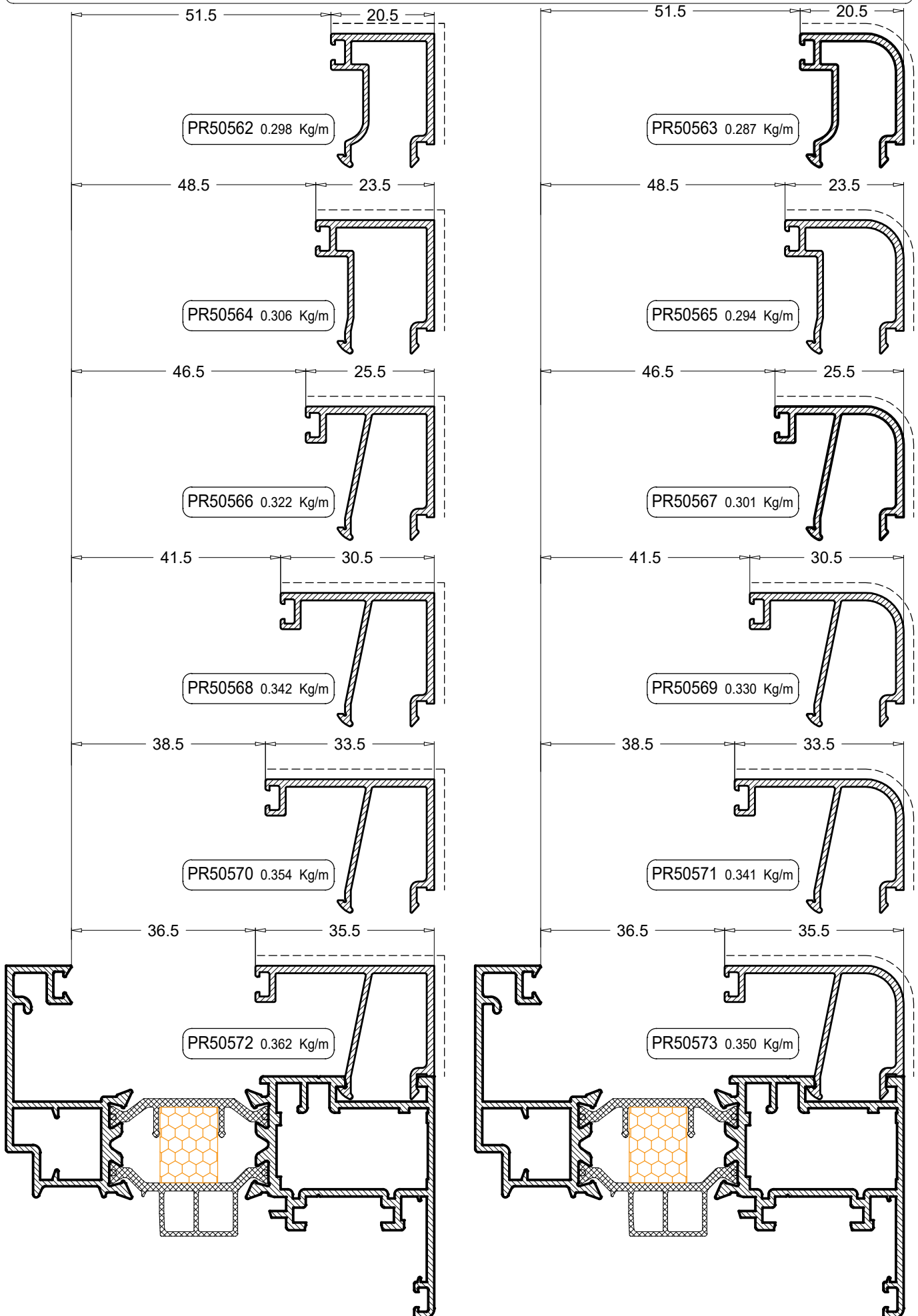

# PROFILI LAJSNE

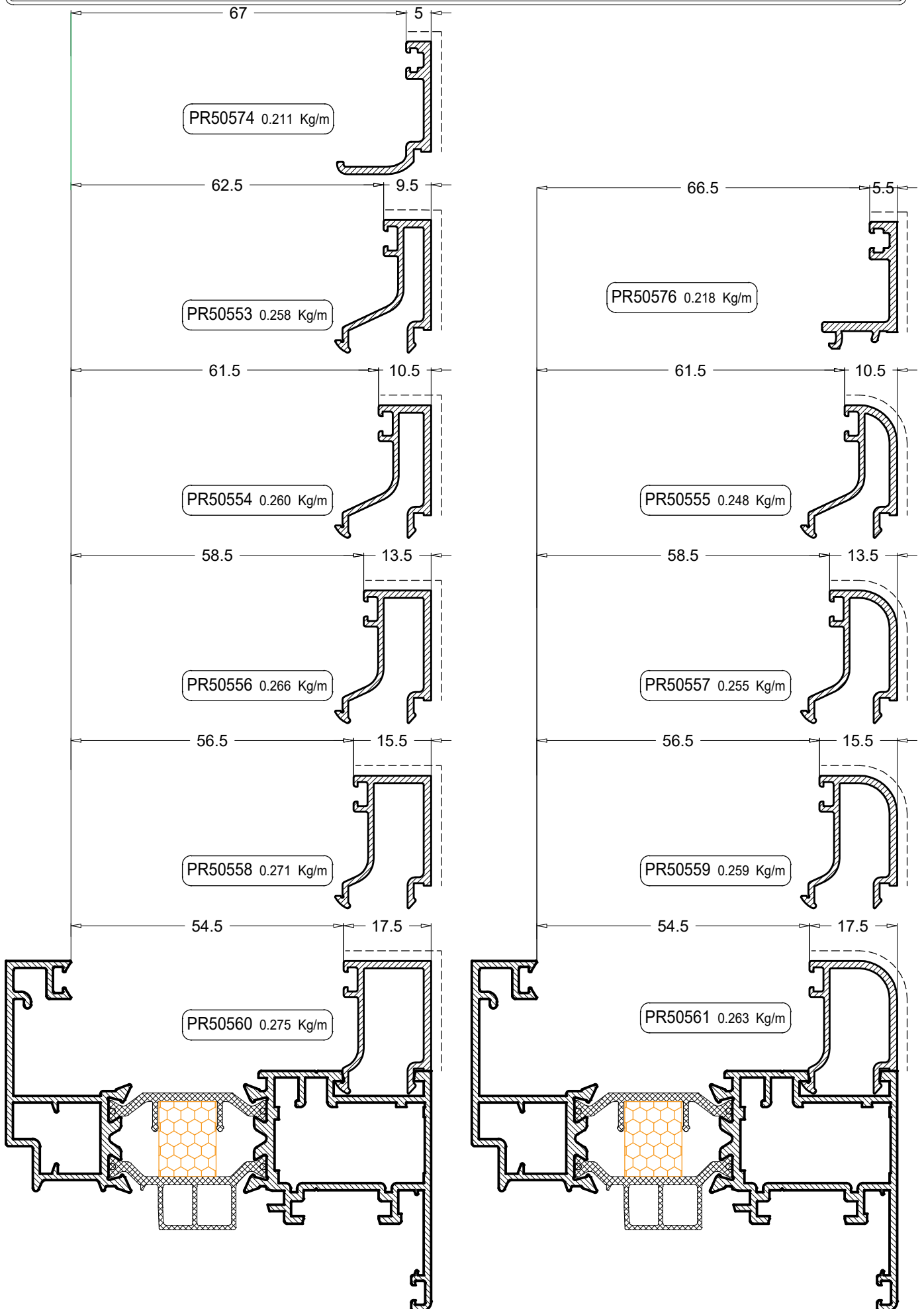

### PROFILI LAJSNE

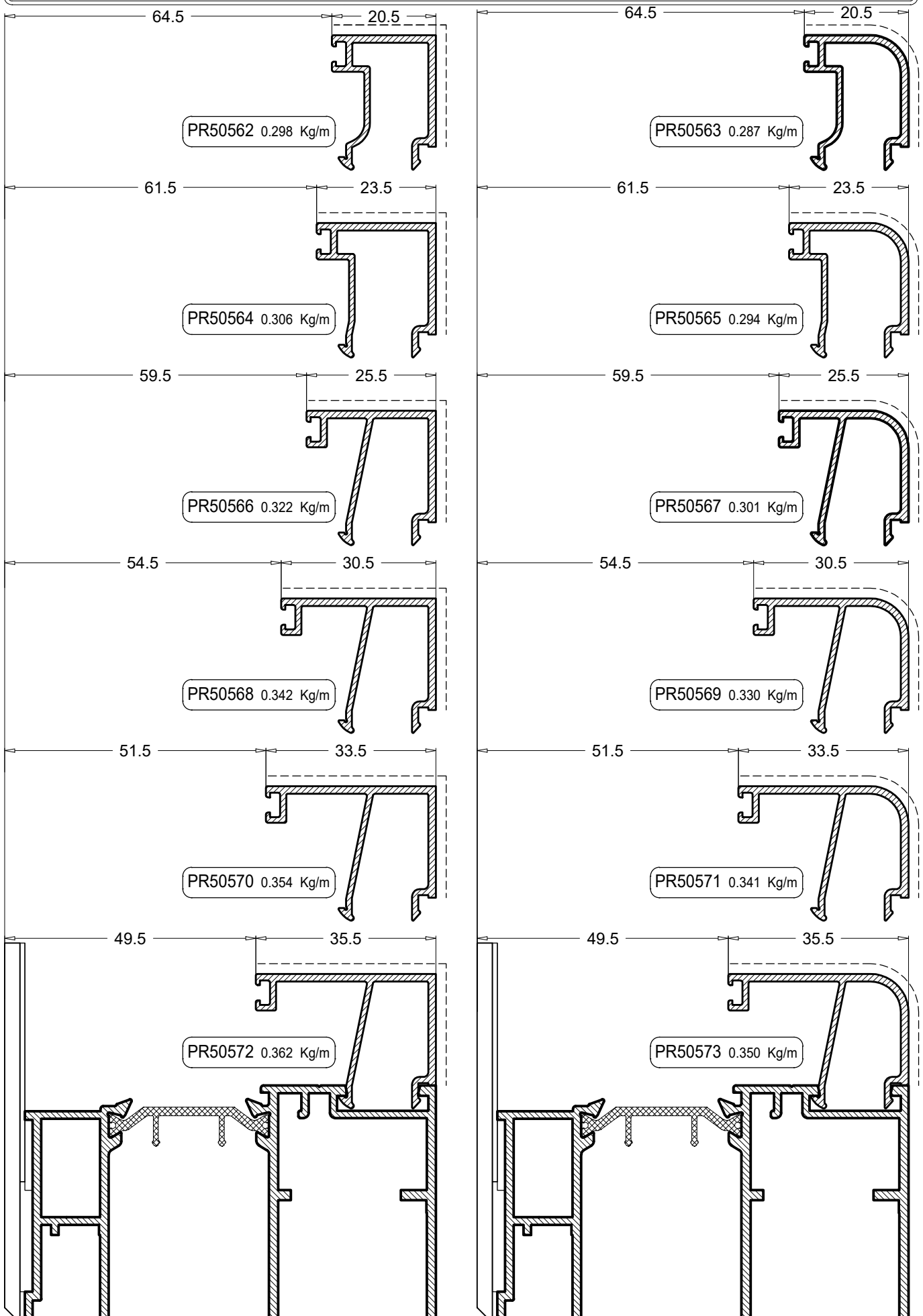



**PROFILI LAJSNE**

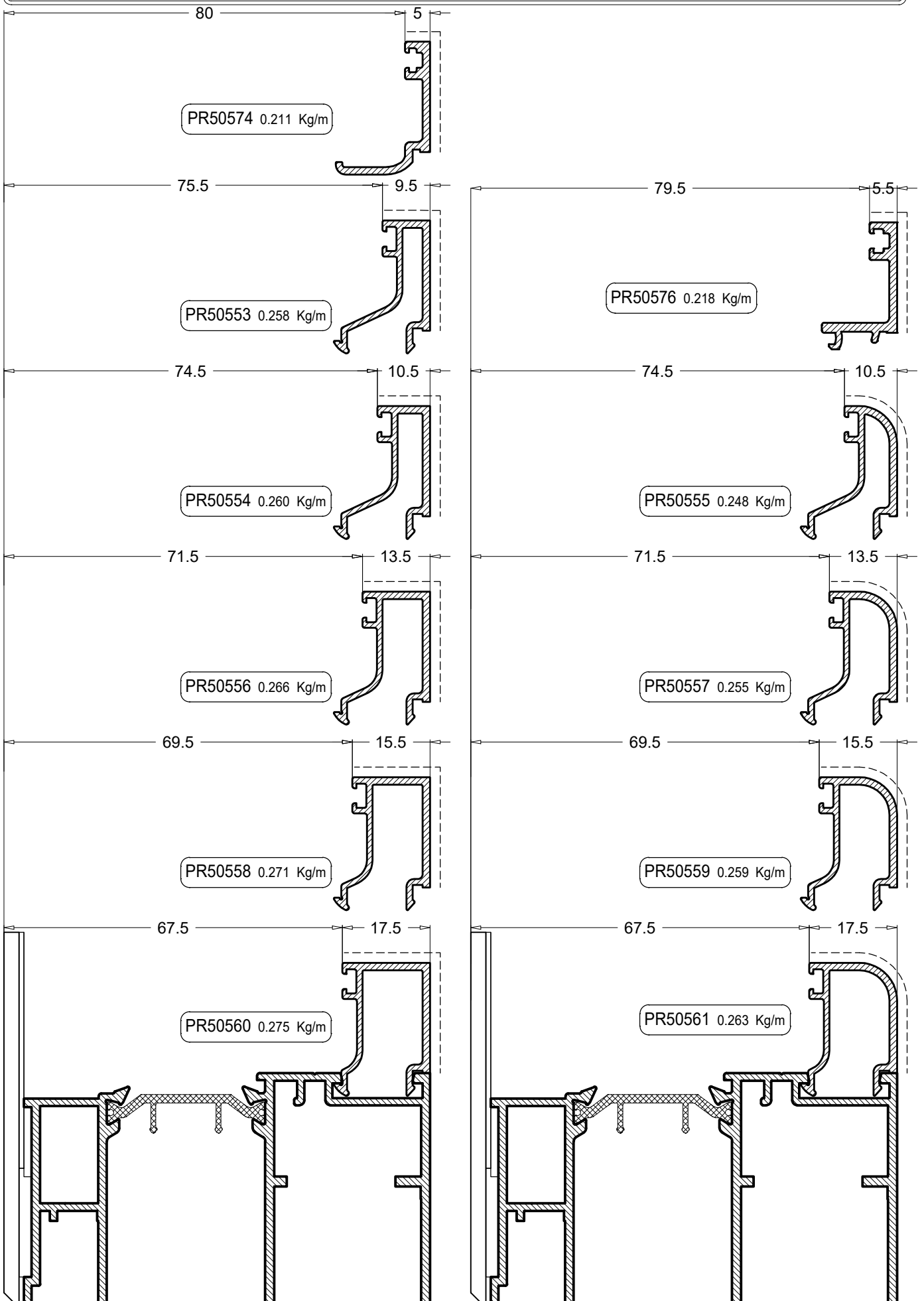

Jednokrilna panel vrata - Široki štok

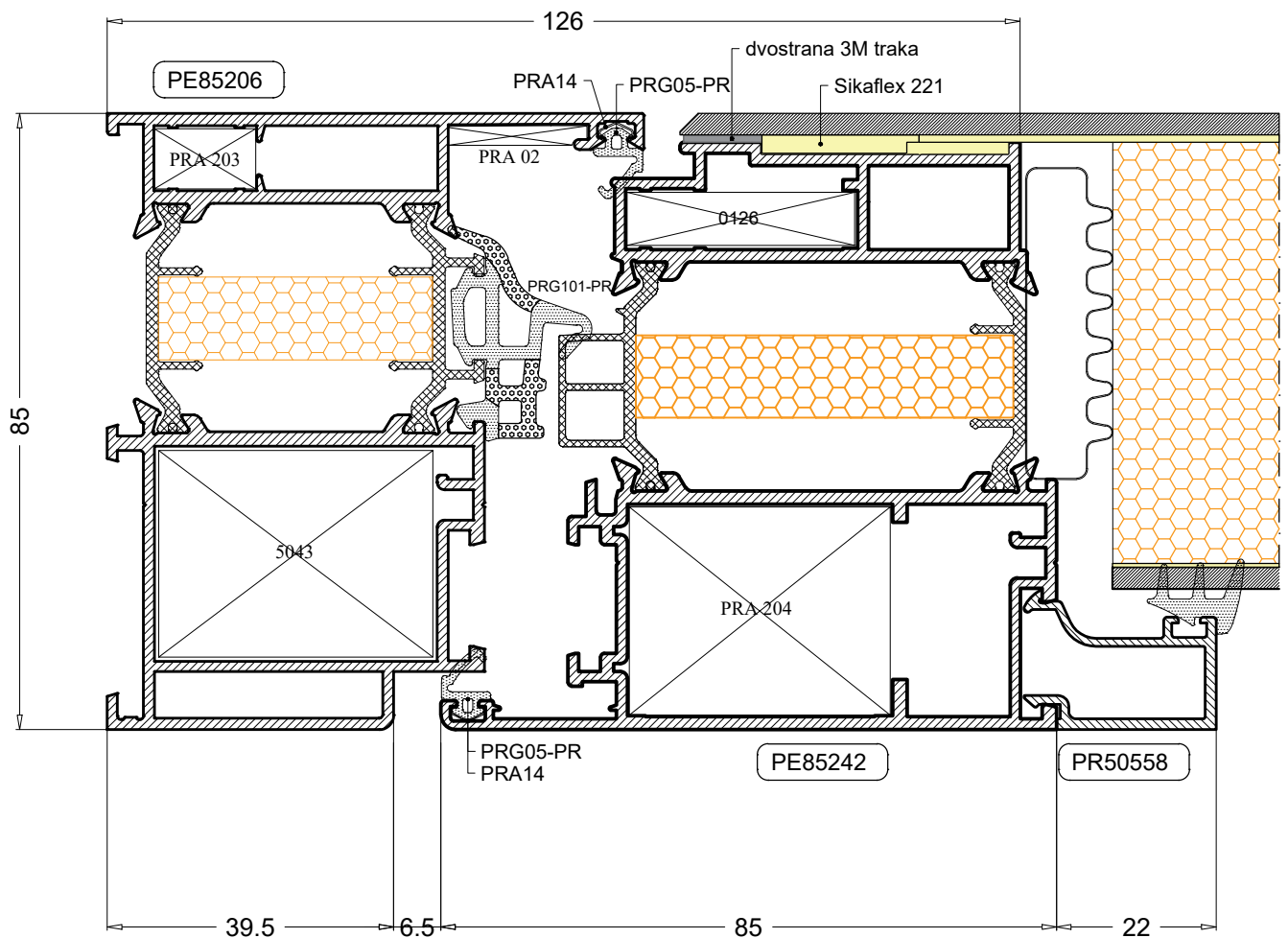
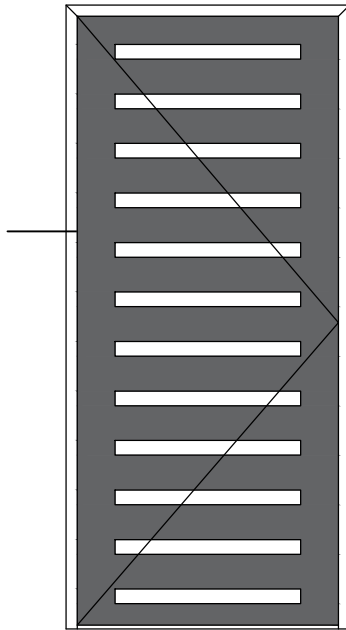

Jednokrilna panel vrata - Široki štok

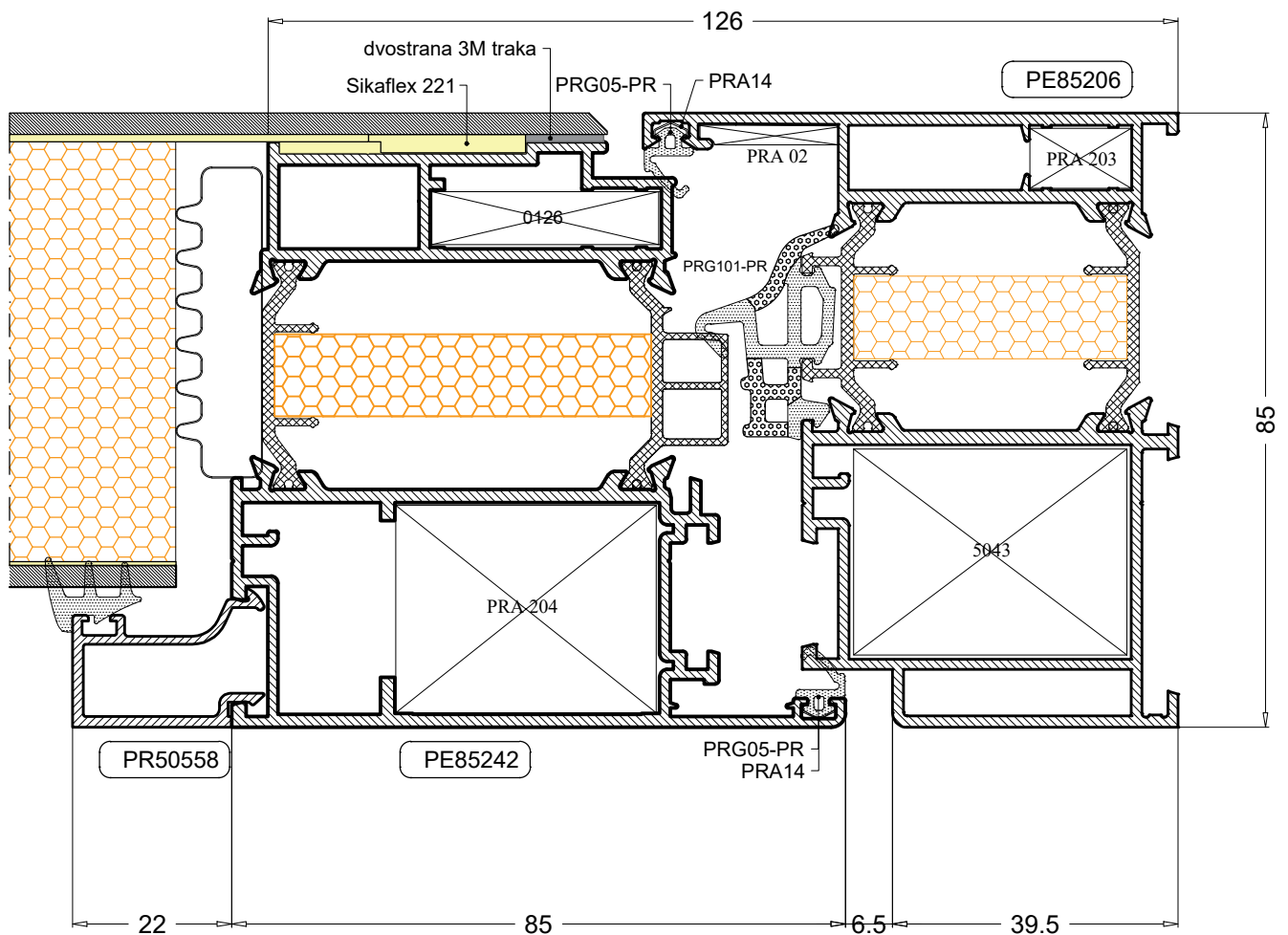
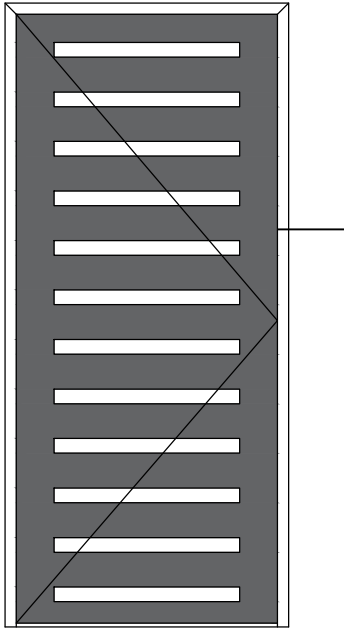

Jednokrillna panel vrata - Široki štok

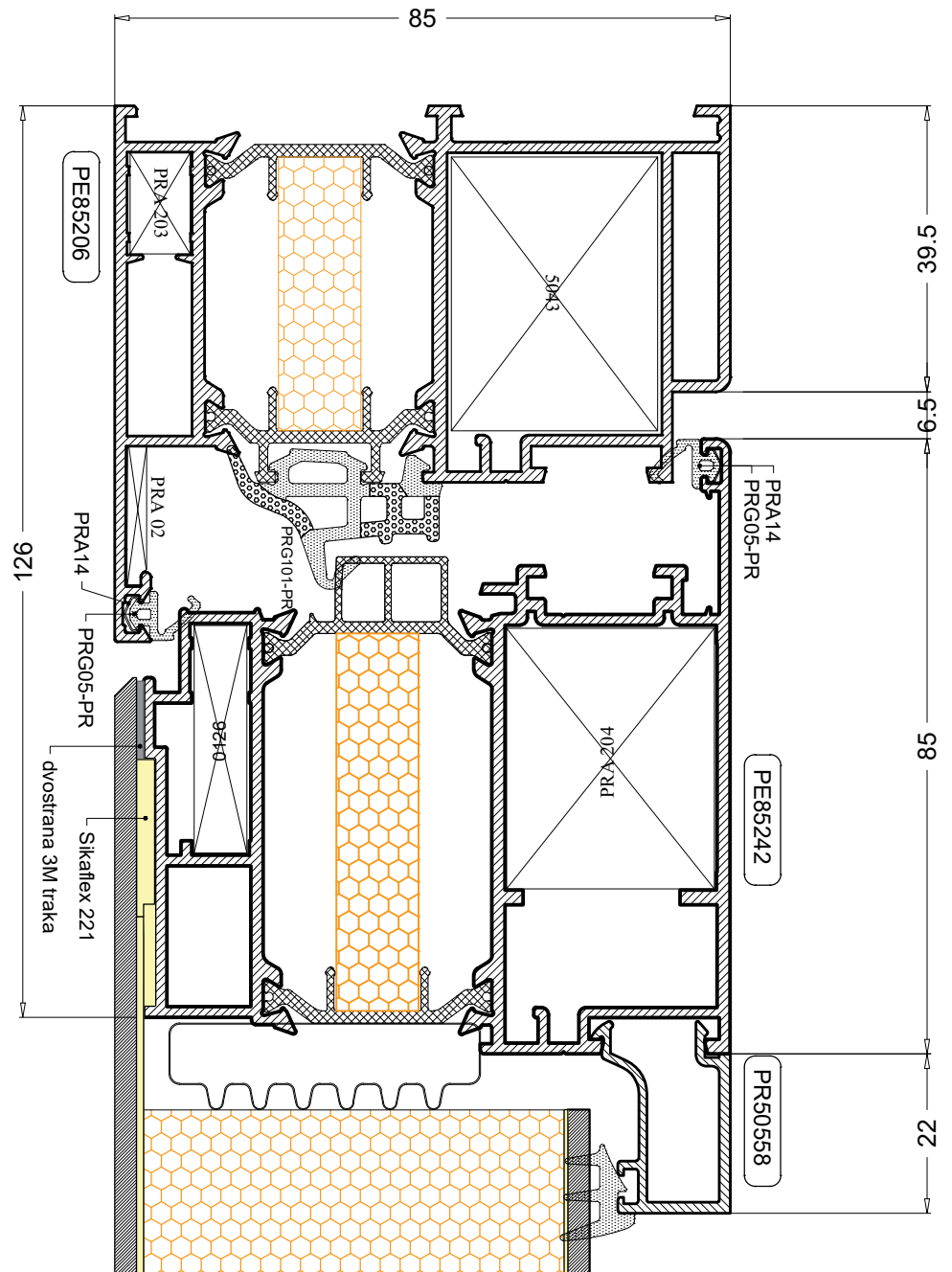
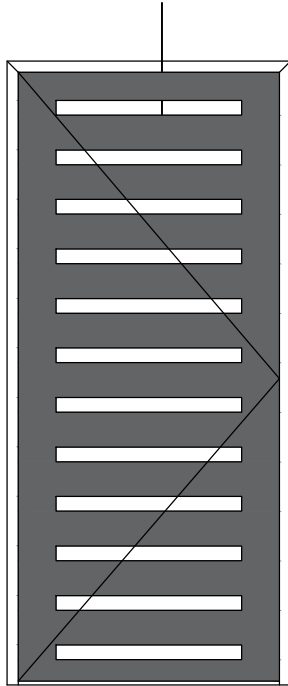

Jednokrilna panel vrata - Široki štok

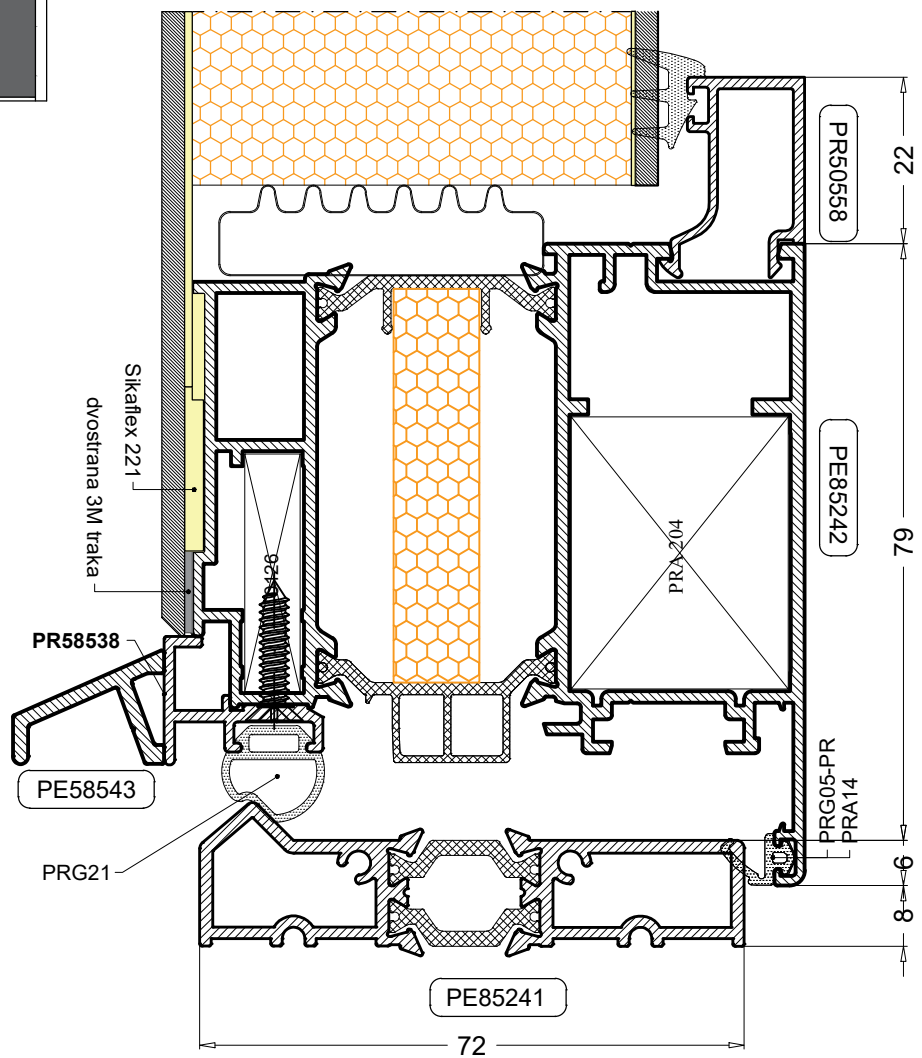
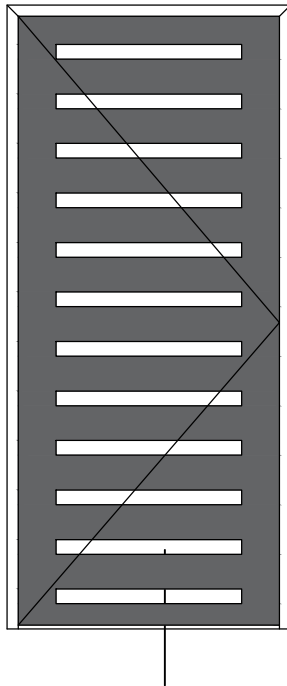

Jednokrilna panel vrata sa fiksnim dijelom - Široki štok

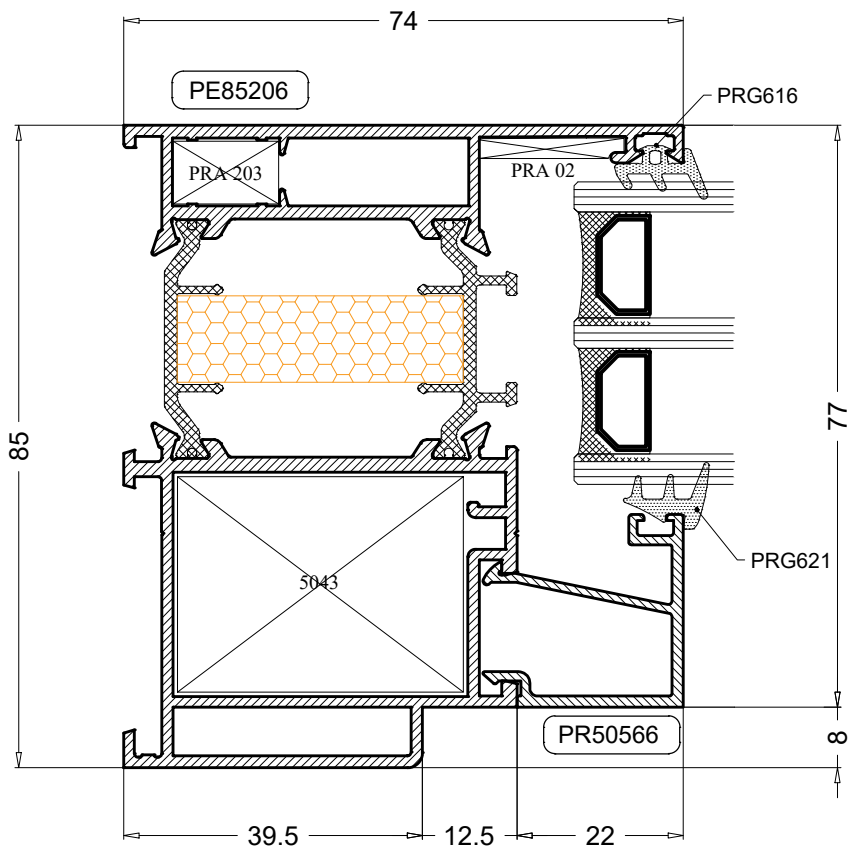
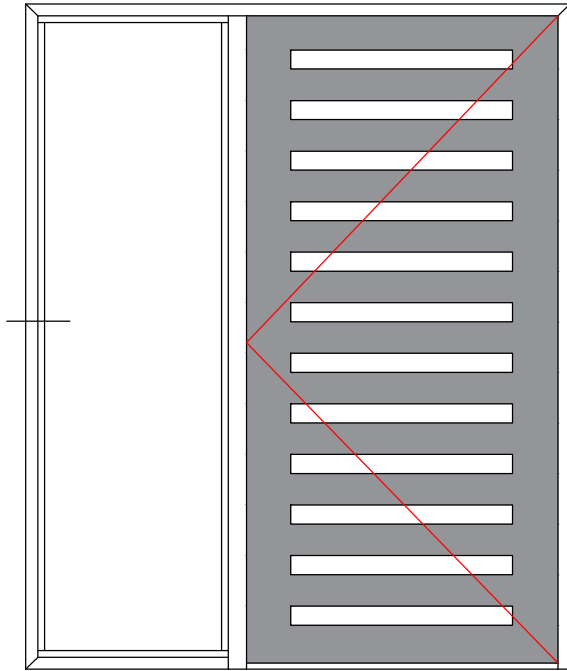

Jednokrilna panel vrata sa fiksnim dijelom - Široki štok

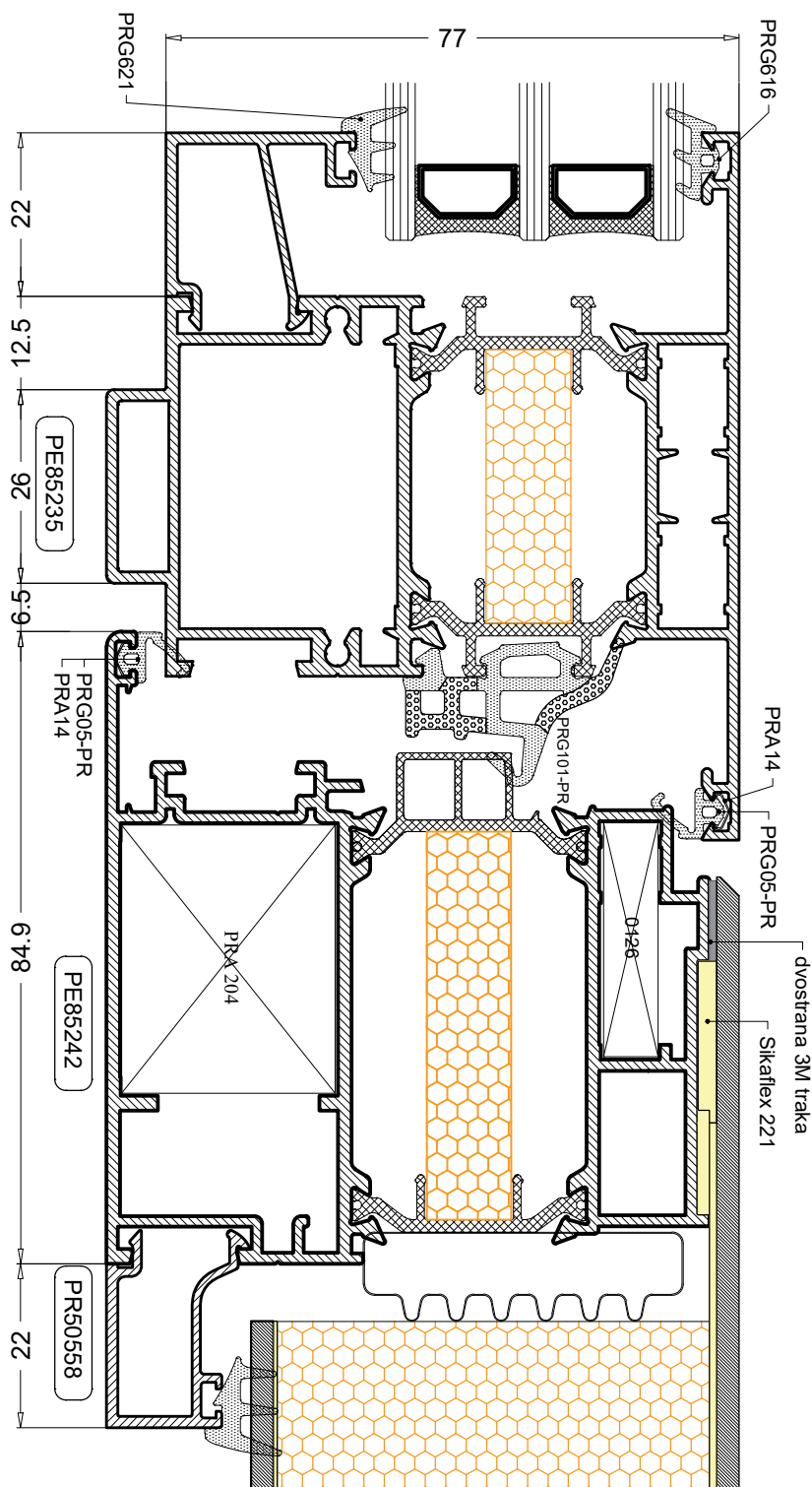
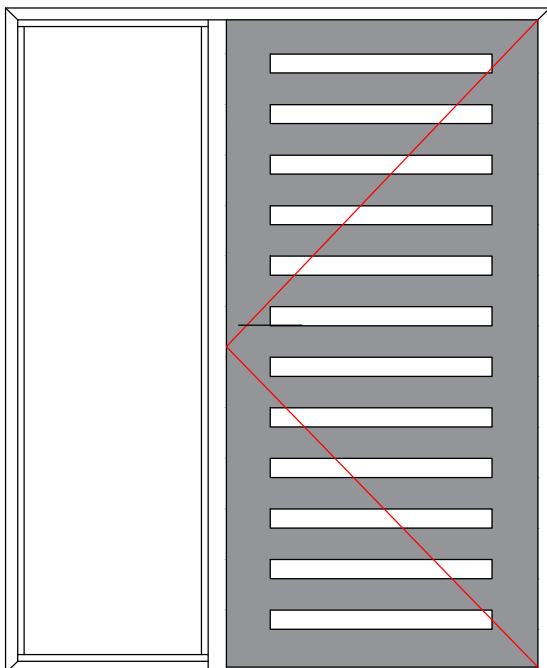

Jednokrilna vrata - Široki štok

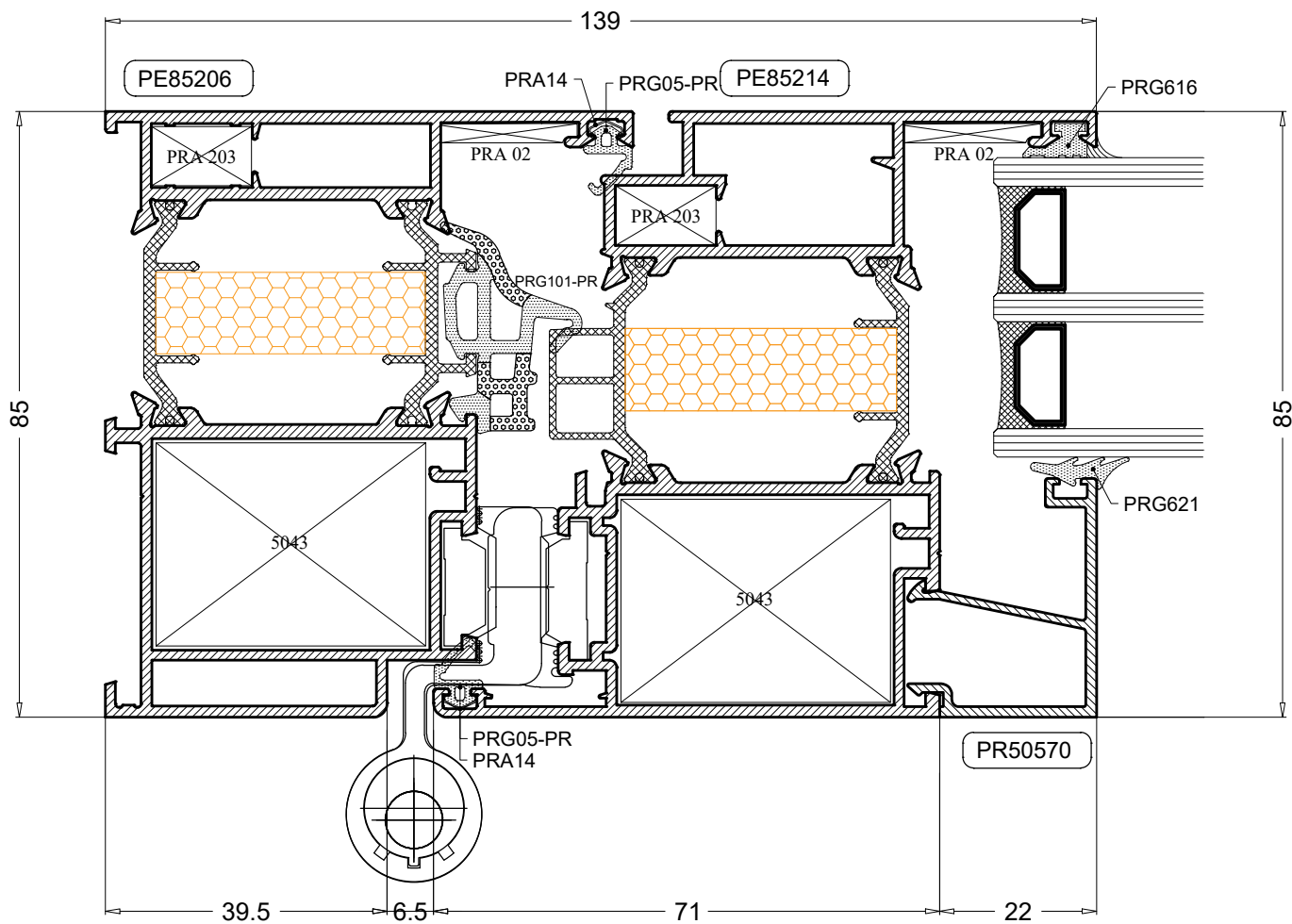
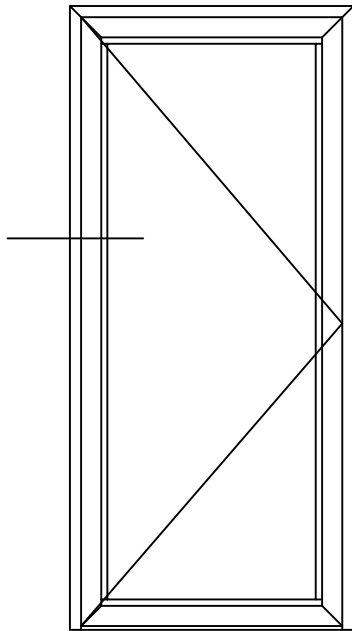



Jednokrilna vrata - Široki štok

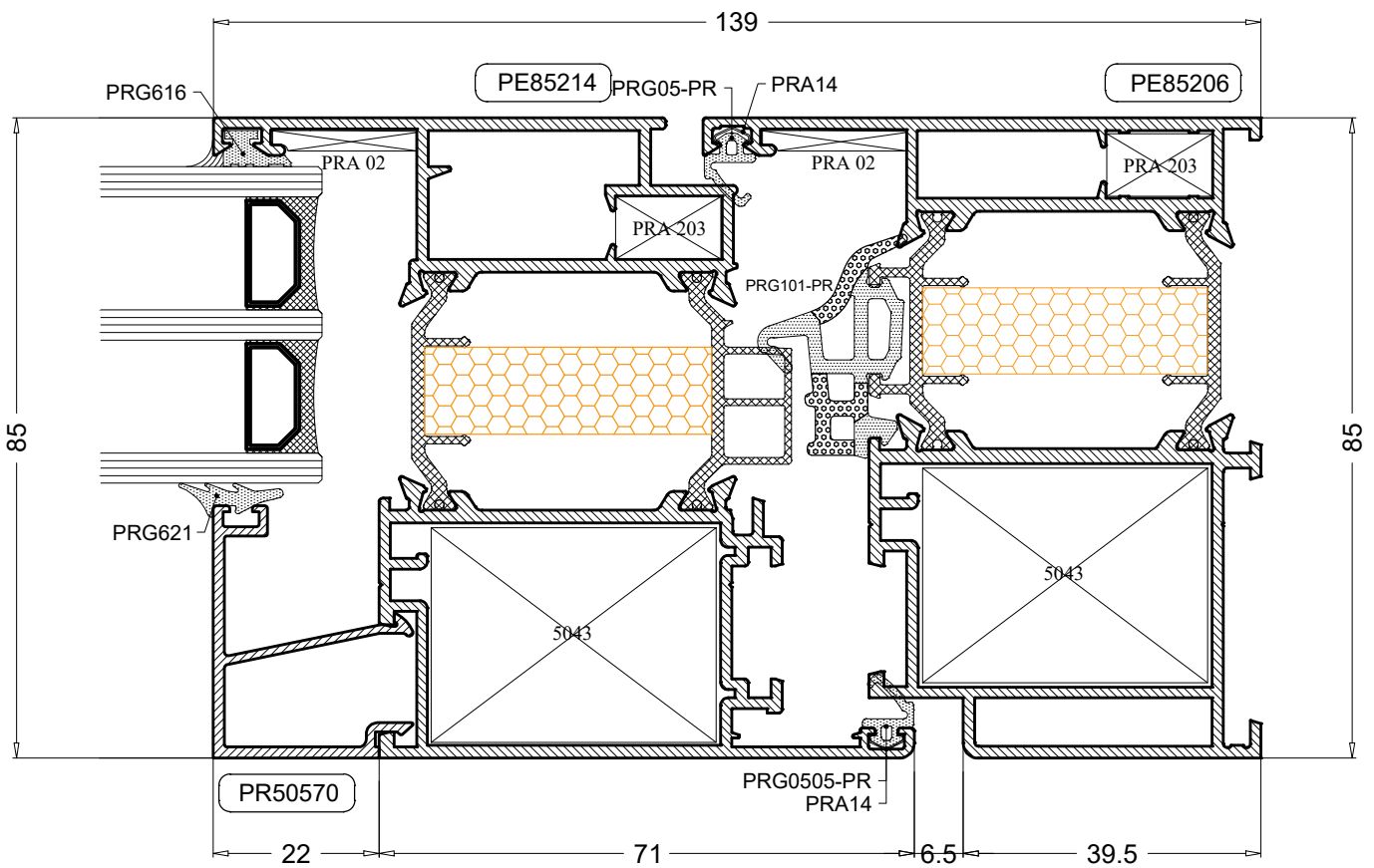
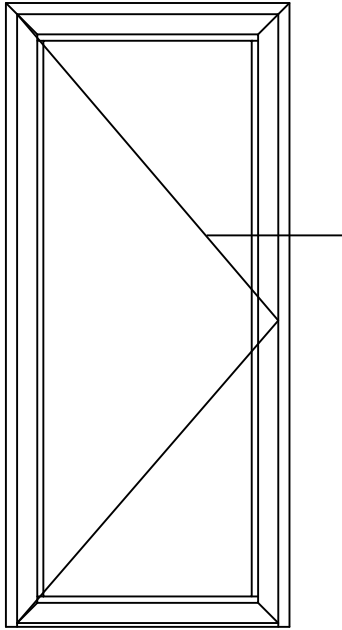

Jednokrilna vrata - Široki štok

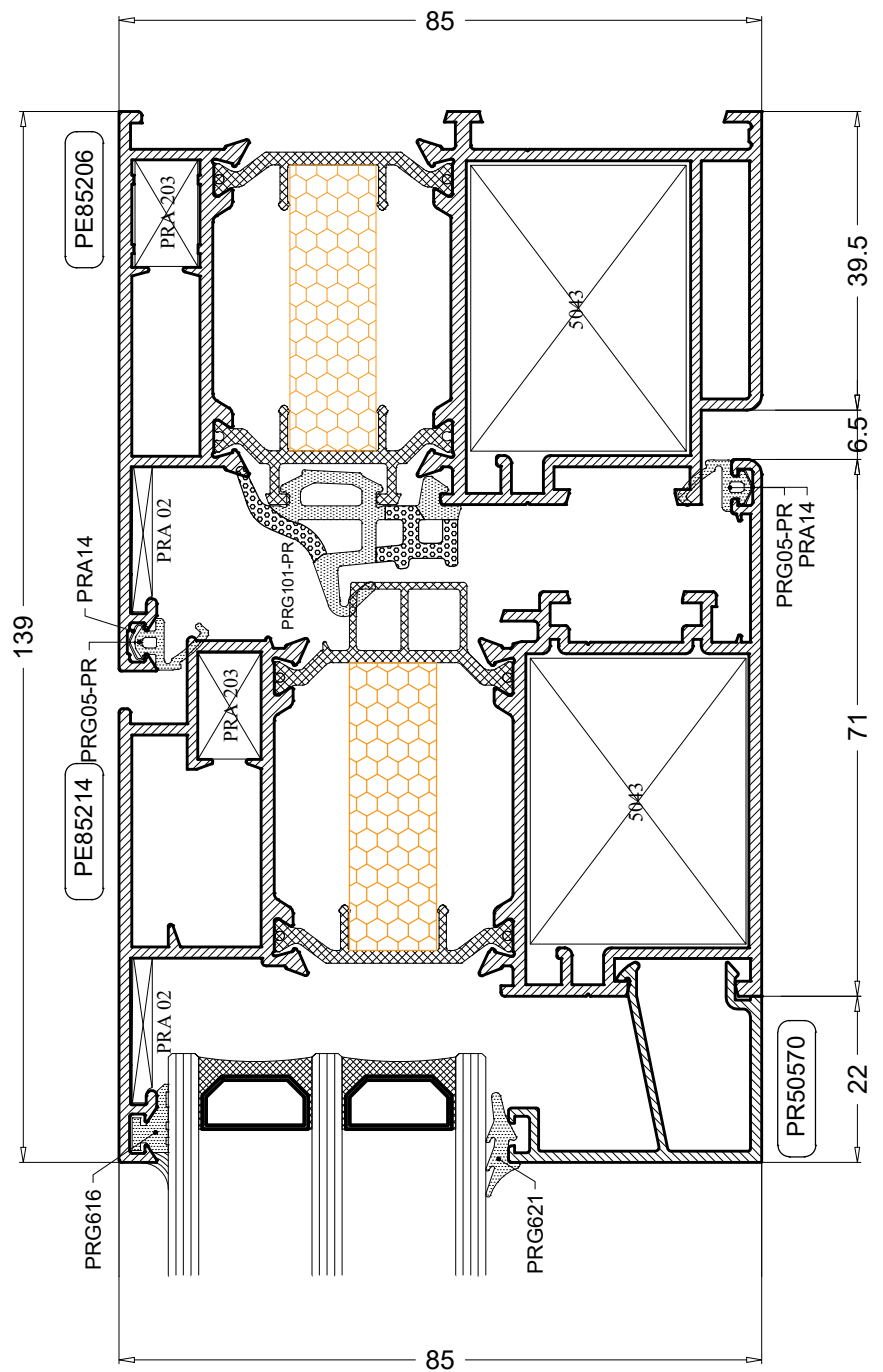
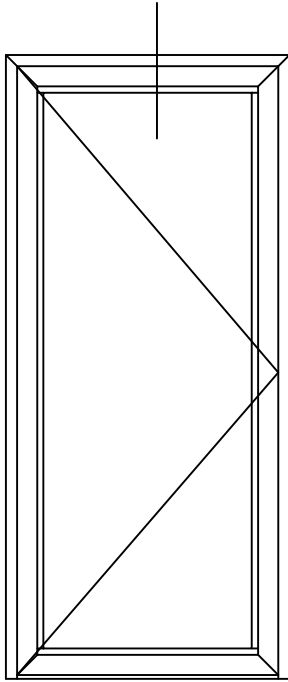

Jednokrilna vrata sa fiksnim dijelom - Široki štok

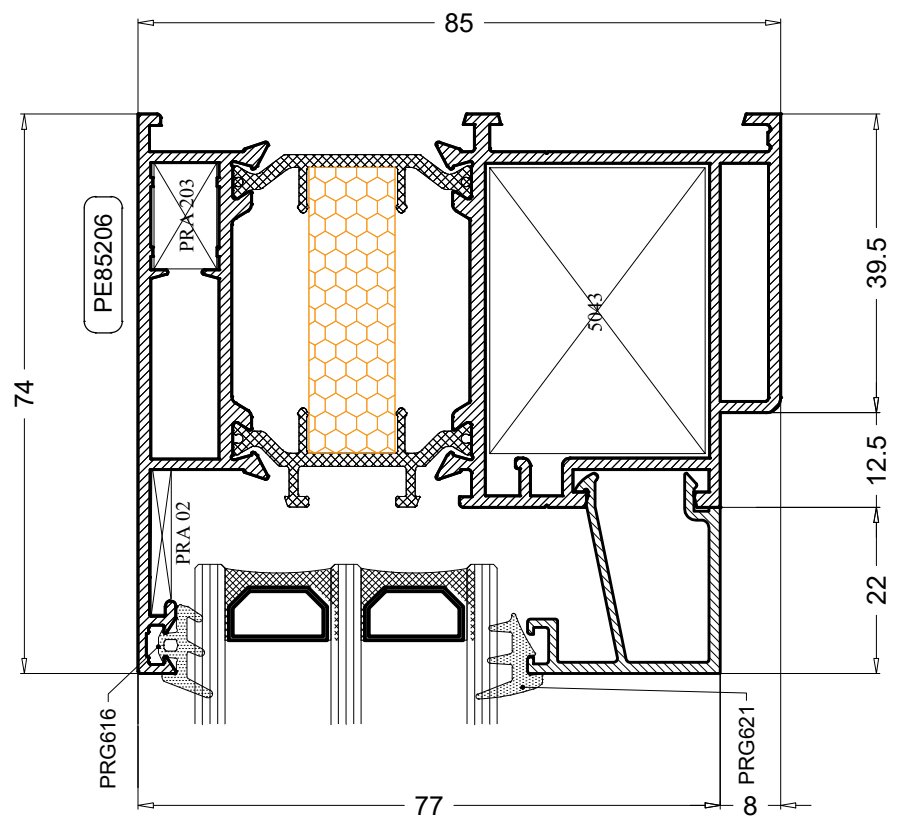
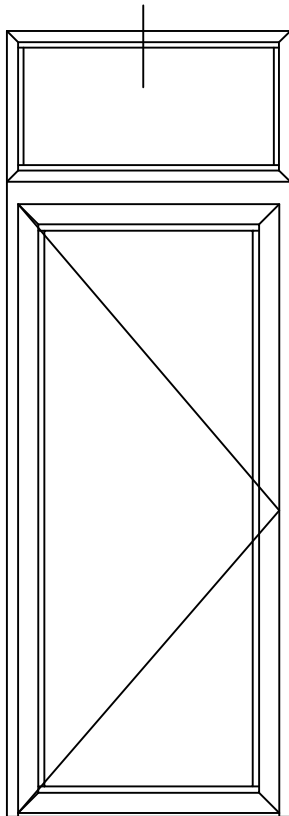

Jednokrilna vrata - Presjek sa pragom

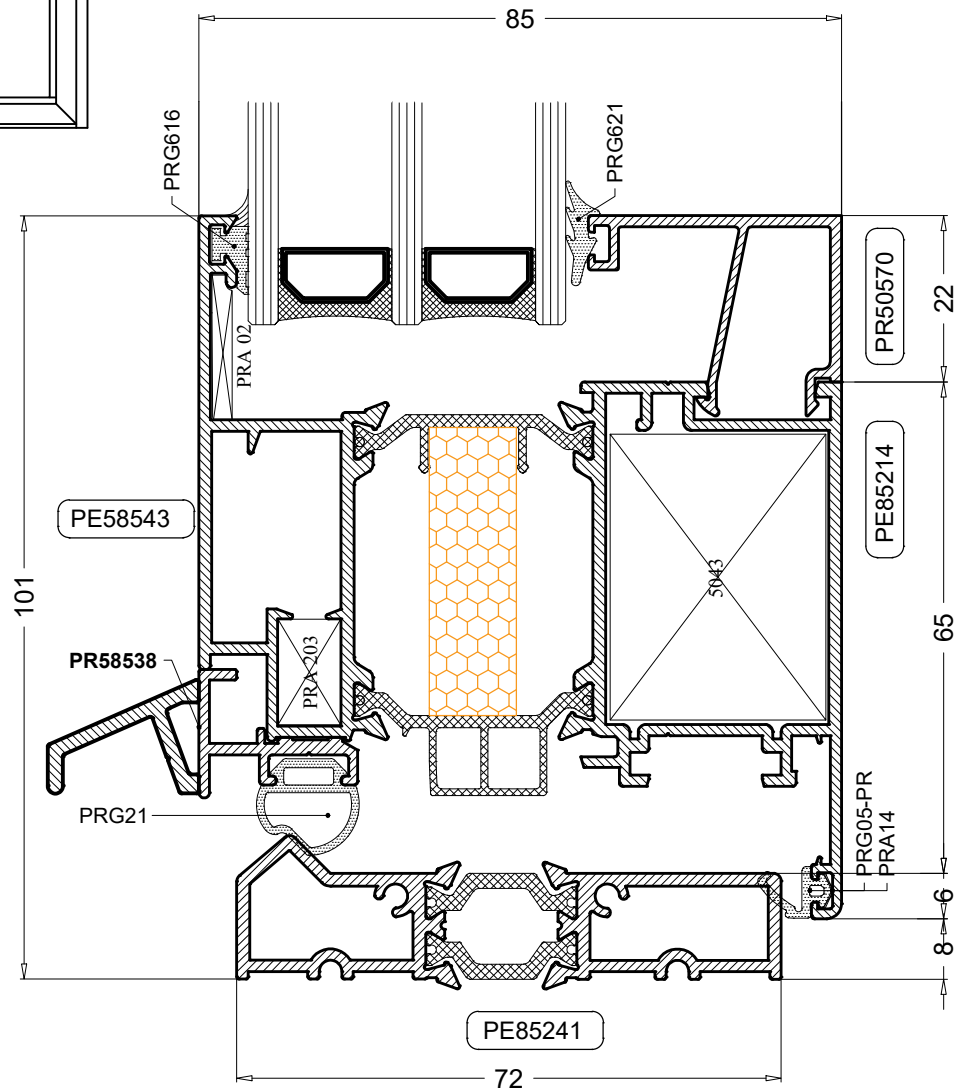
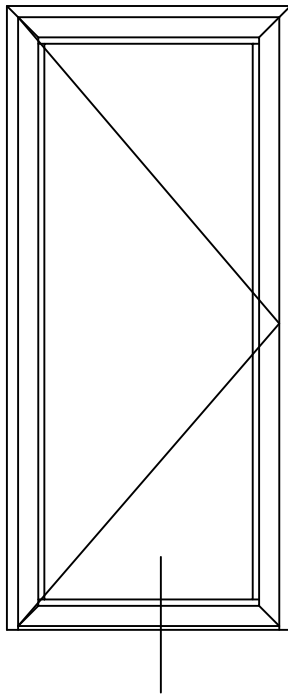

Jednokrilna vrata sa fiksnim dijelom - Široki štok

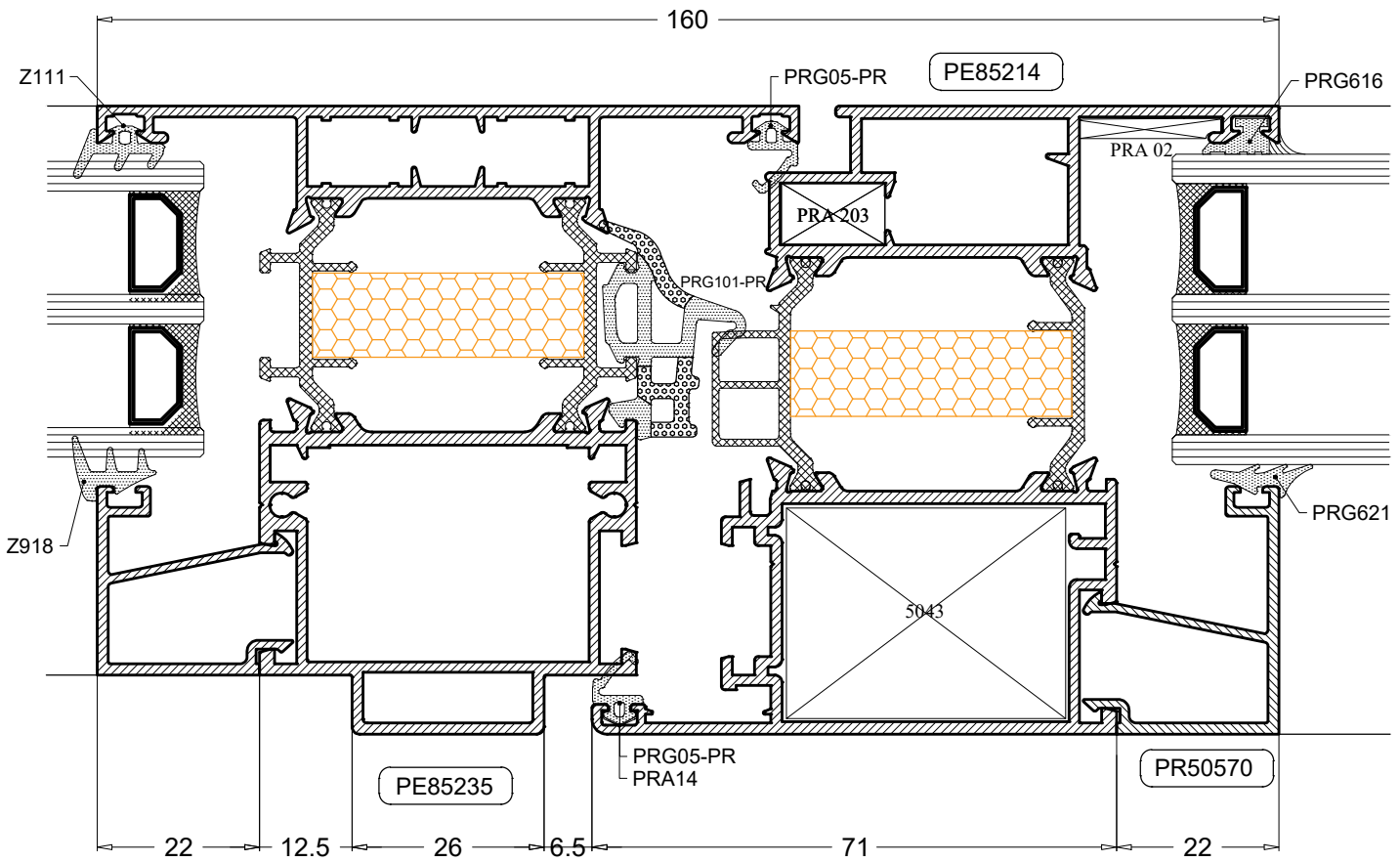
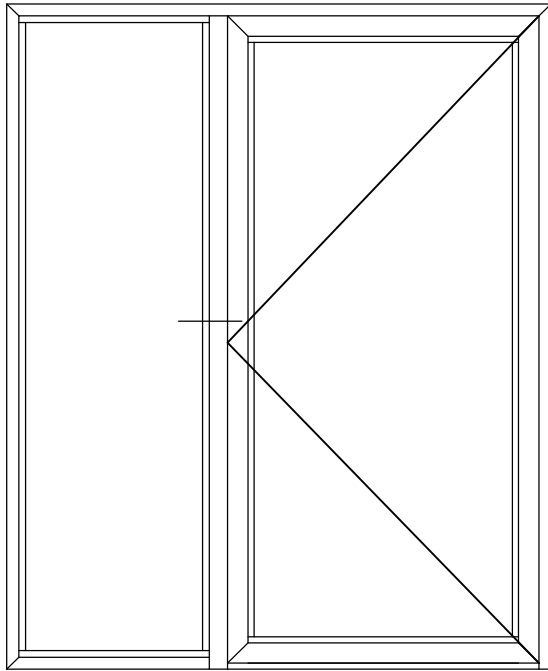

Jednokrilna vrata sa ventusom - Široki štok

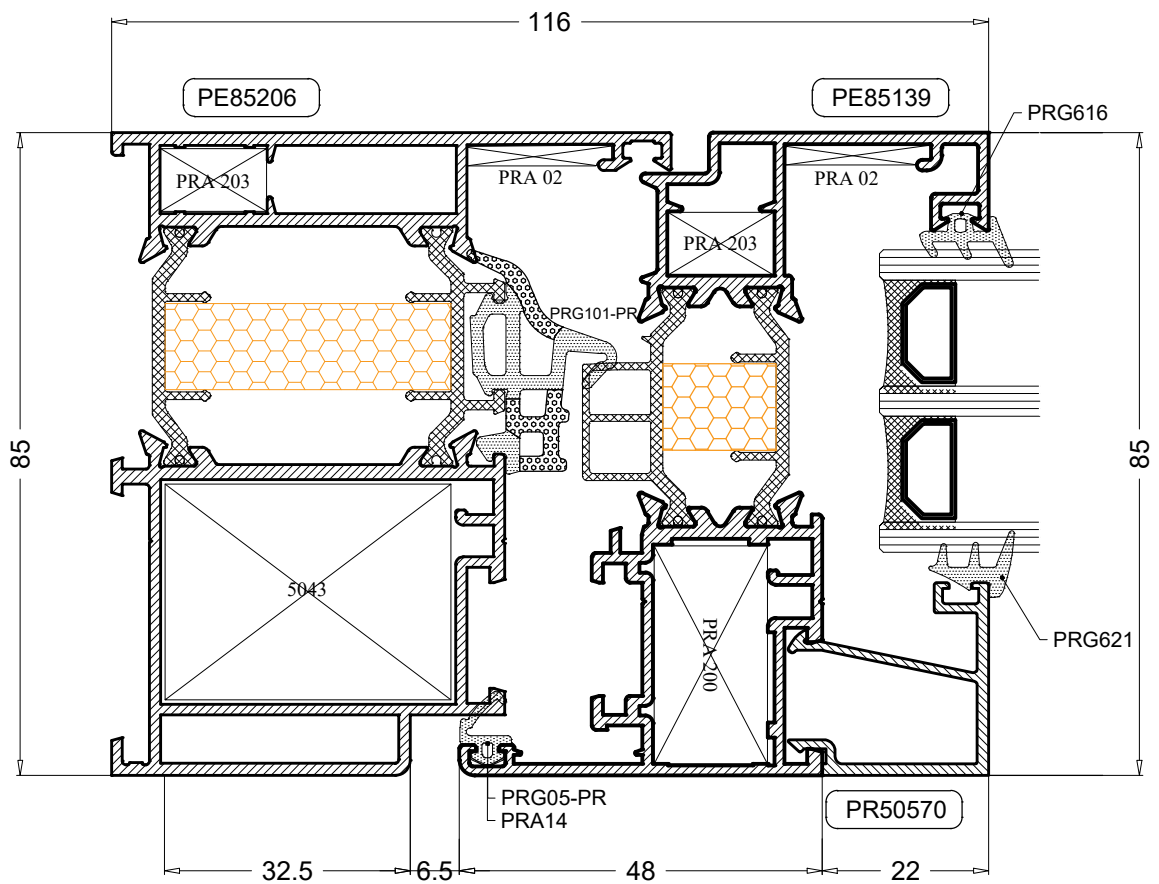
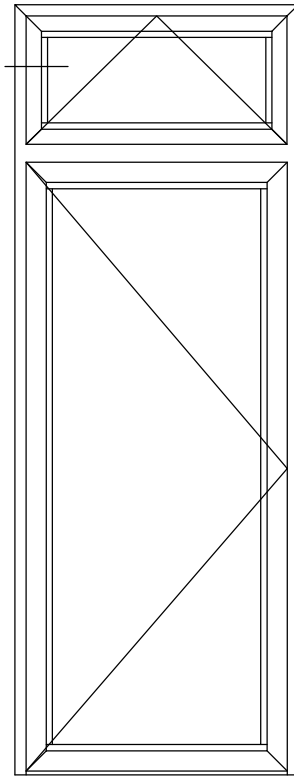

Jednokrilna vrata sa ventusom - Široki štok

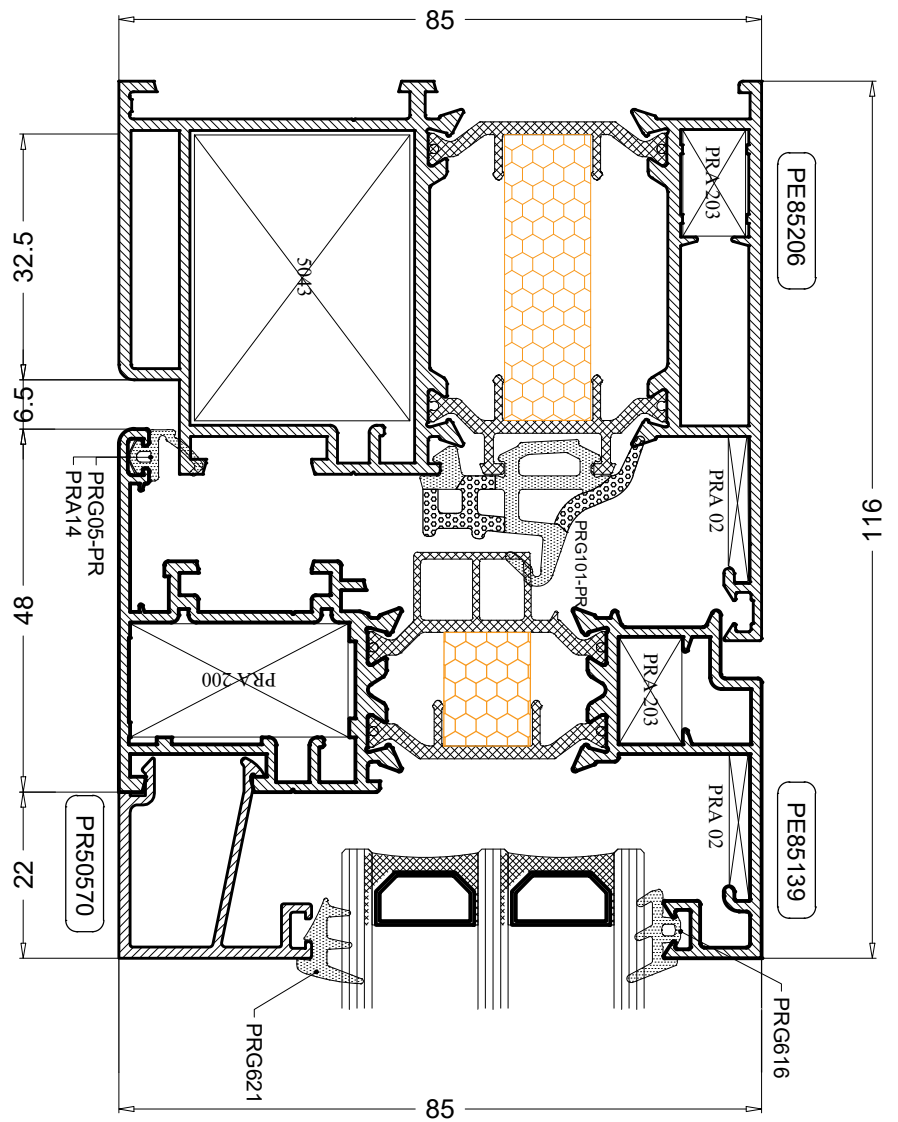
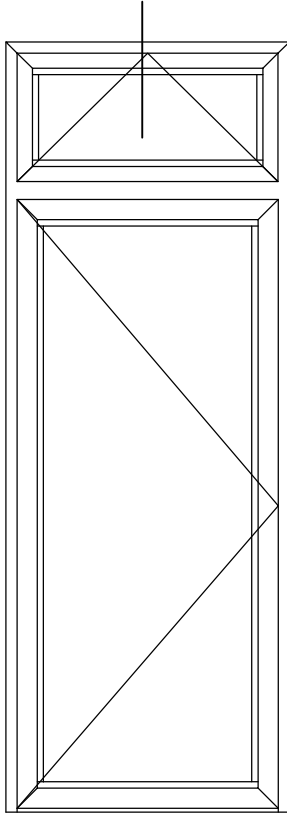

Jednokrilna vrata - Uski štok

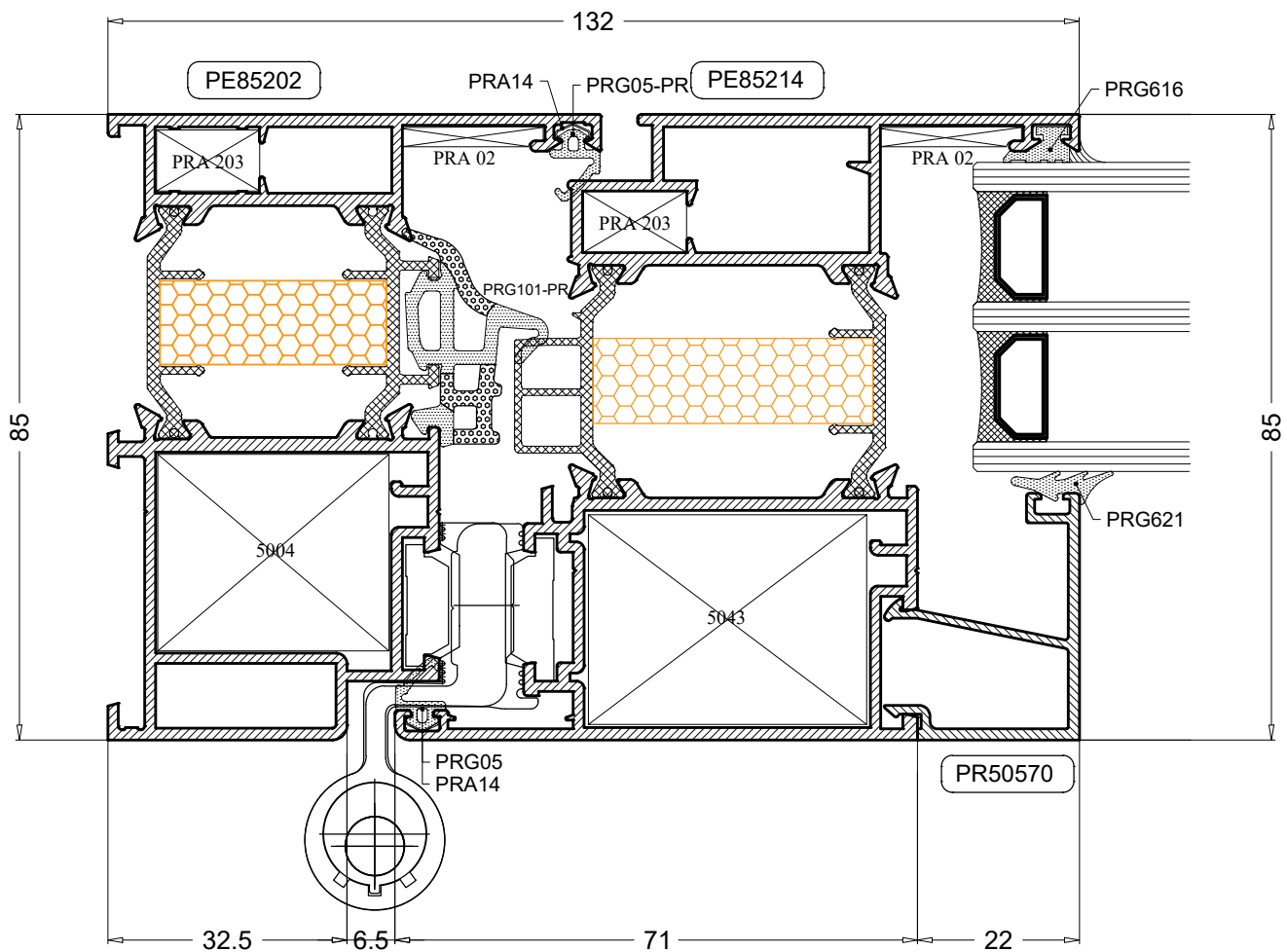
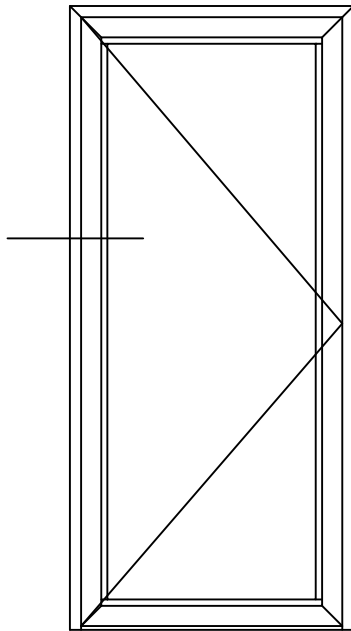



Jednokrilna vrata - Uski štok

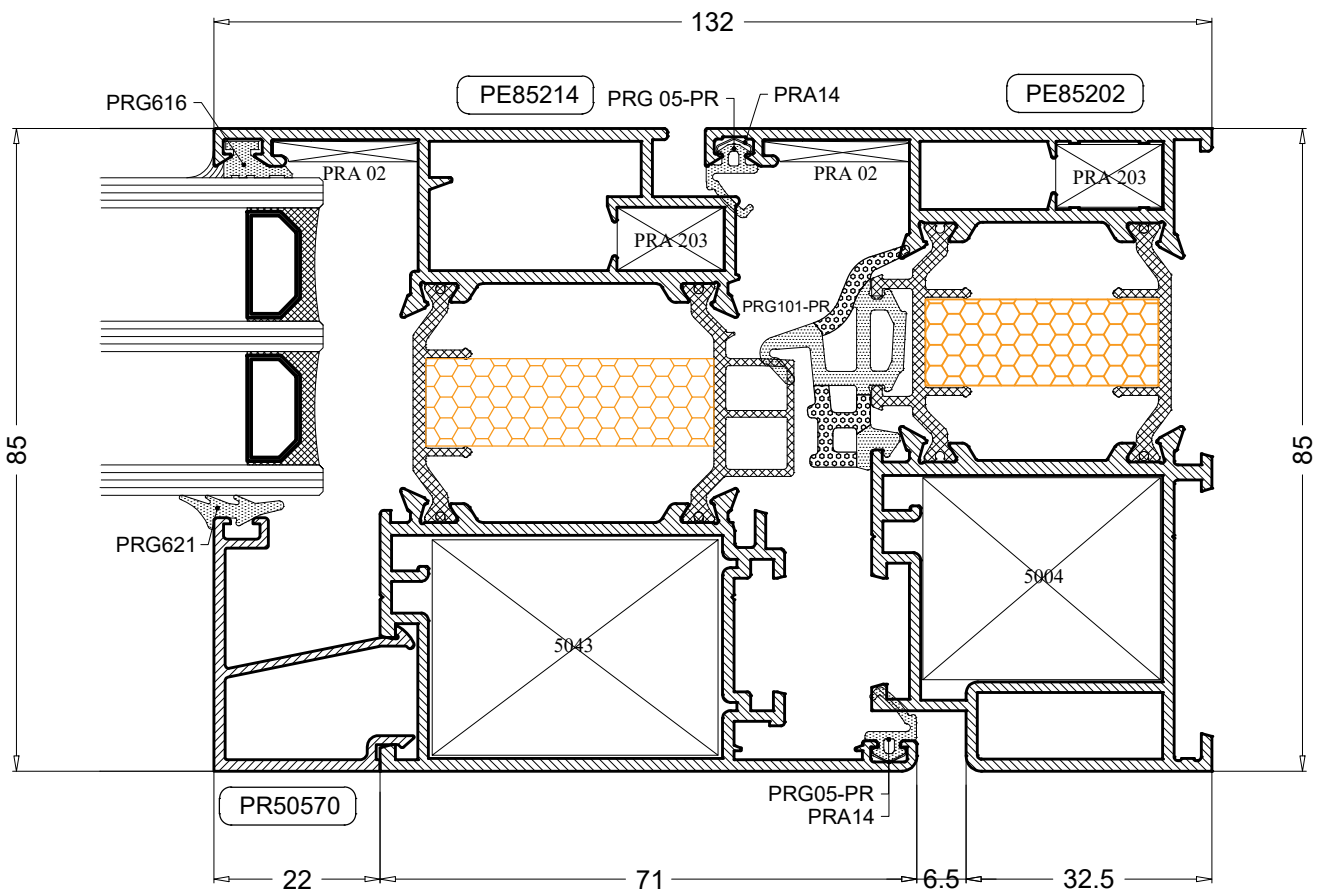
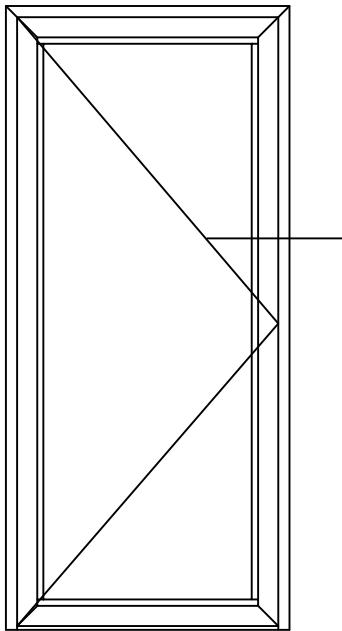

Jednokrilna vrata - Uski štok

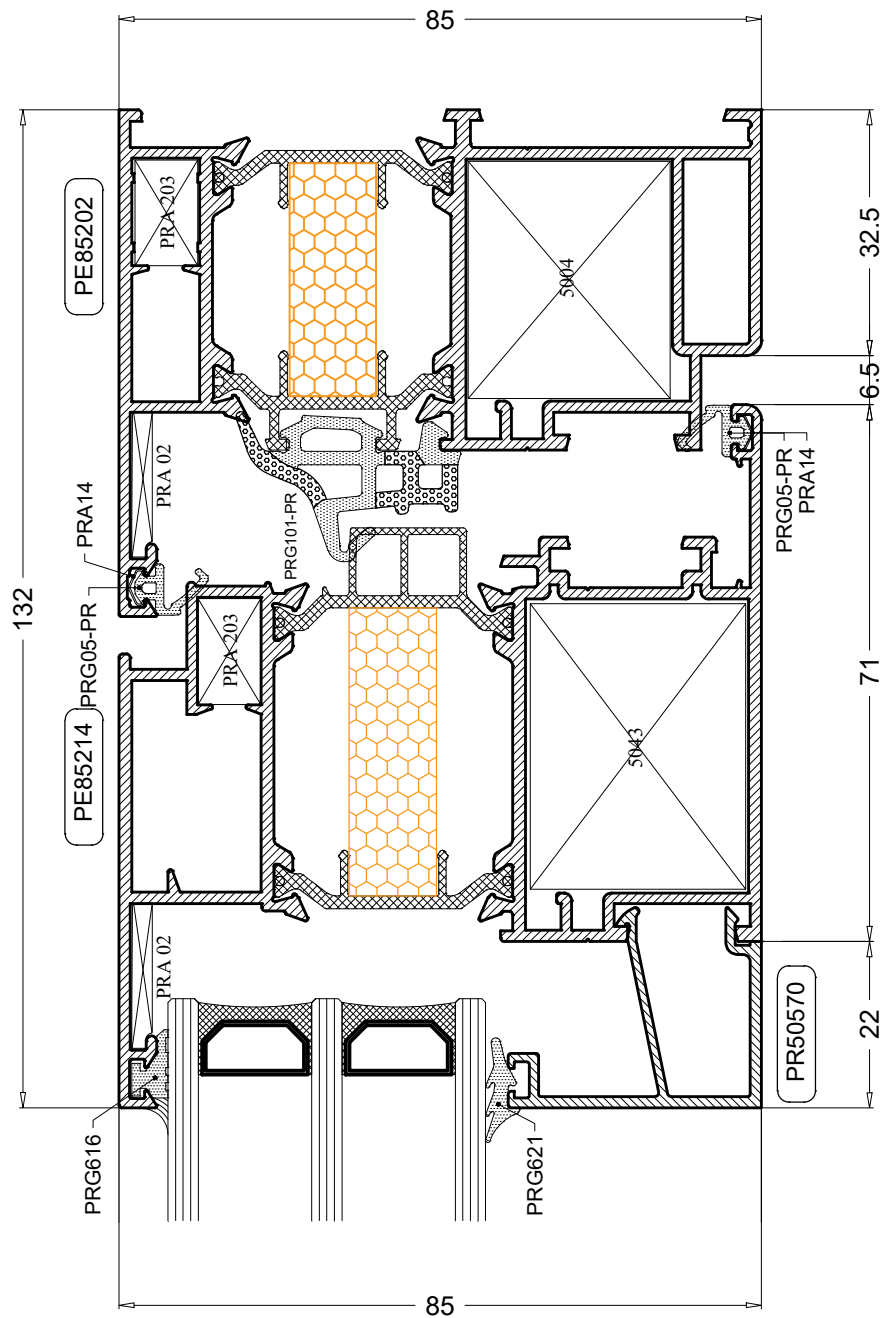
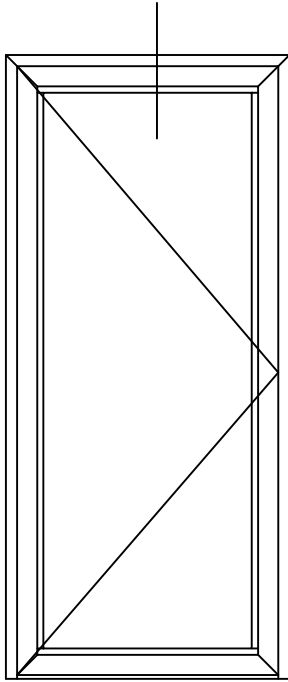

Jednokrilna vrata sa gornjim fiksnim dijelom

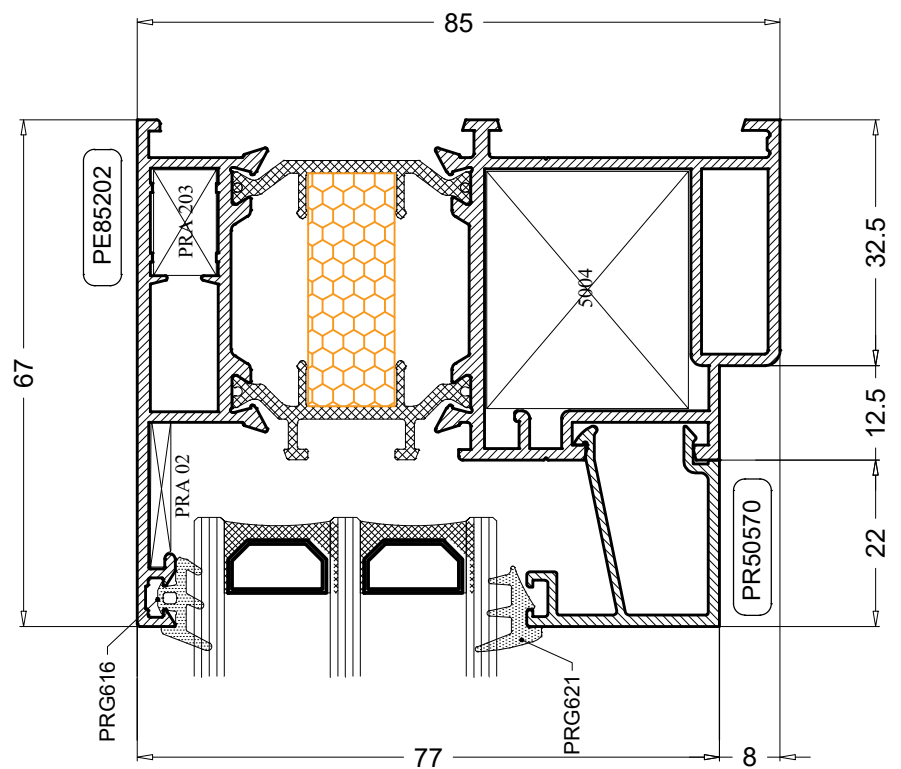
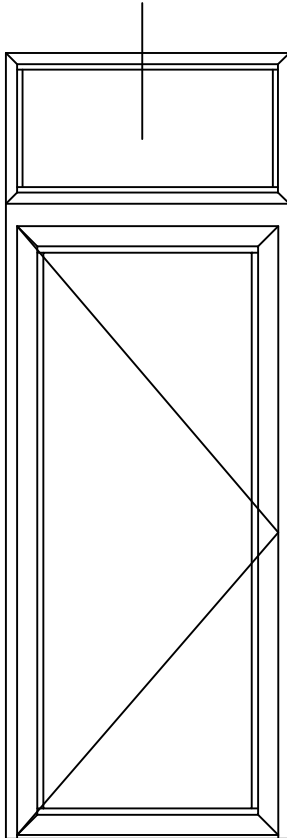

Jednokrilna vrata sa fiksnim dijelom - Uski štok

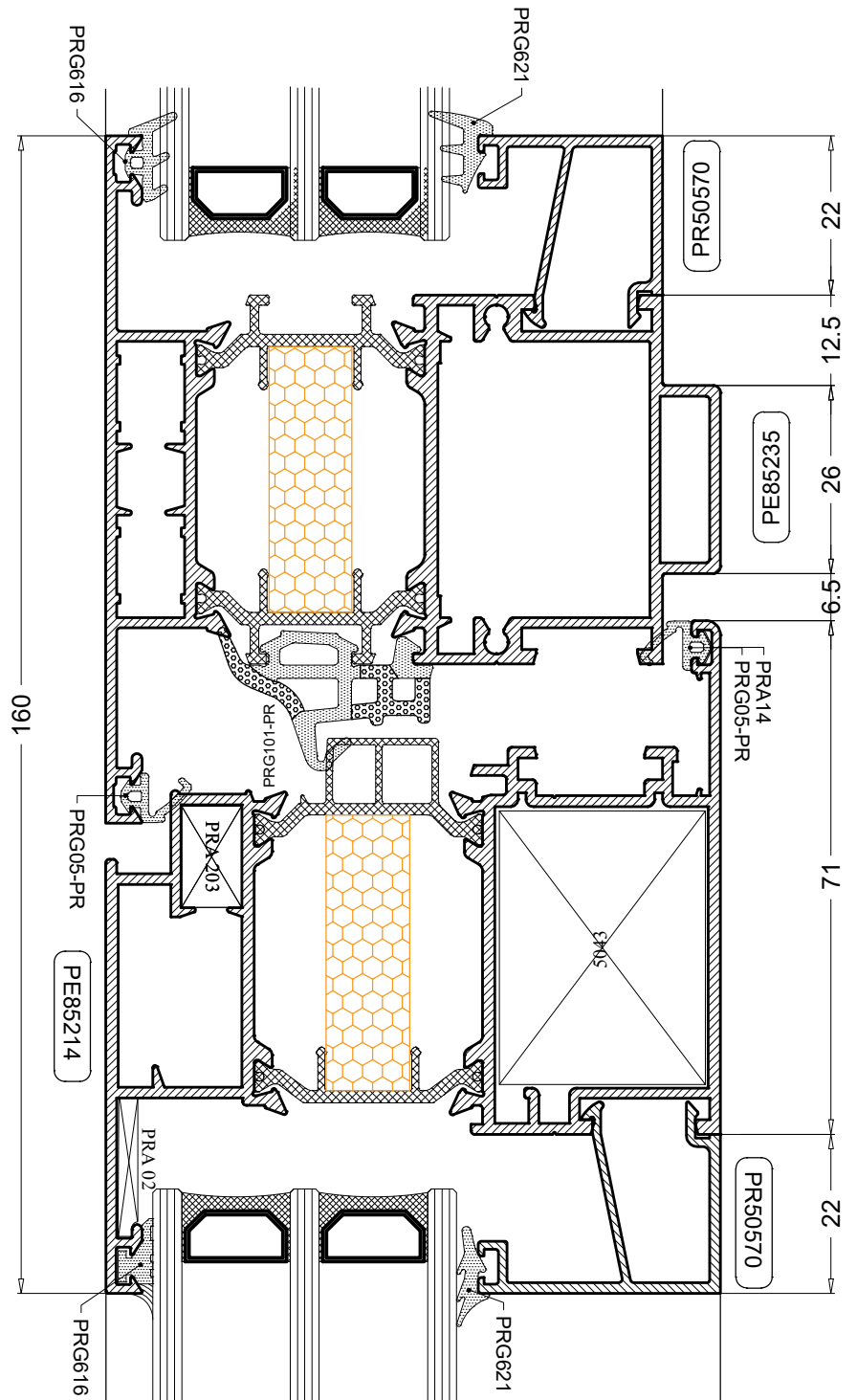
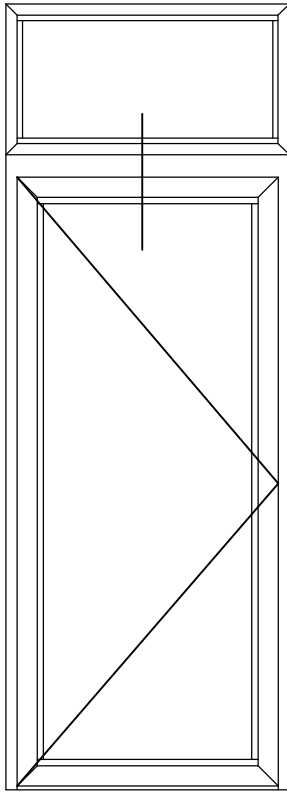

Jednokrilna vrata sa fiksnim dijelom - Unutarne otvaranje - Uski štok

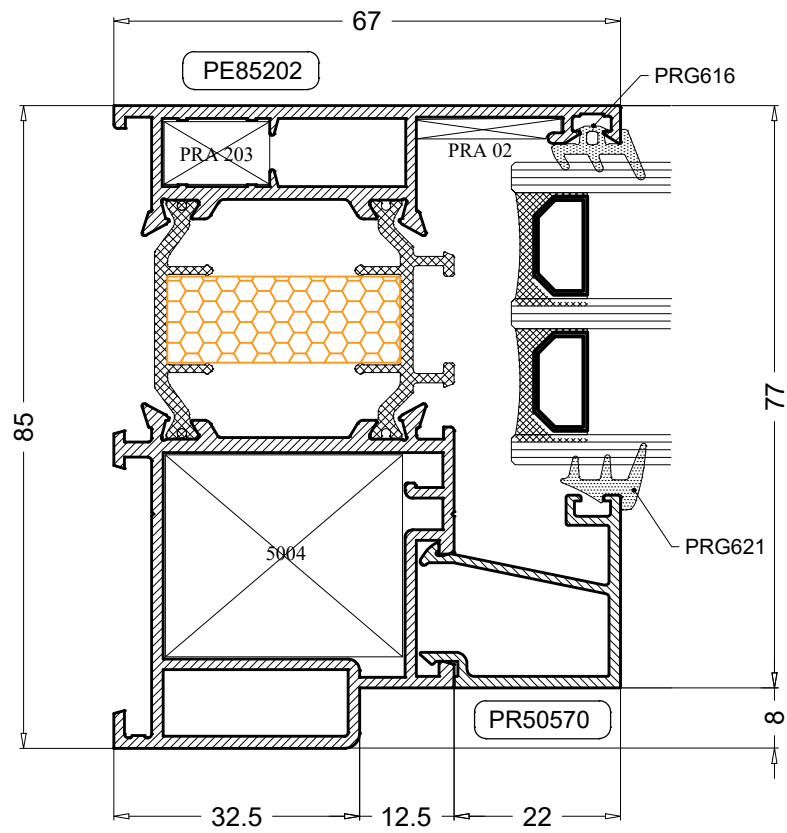
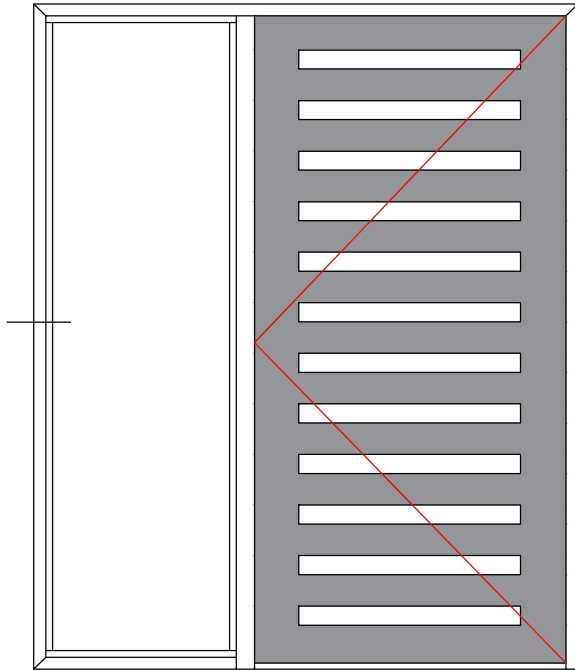

Jednokrilna vrata sa ventusom - Unutarnje otvaranje - Uski štok

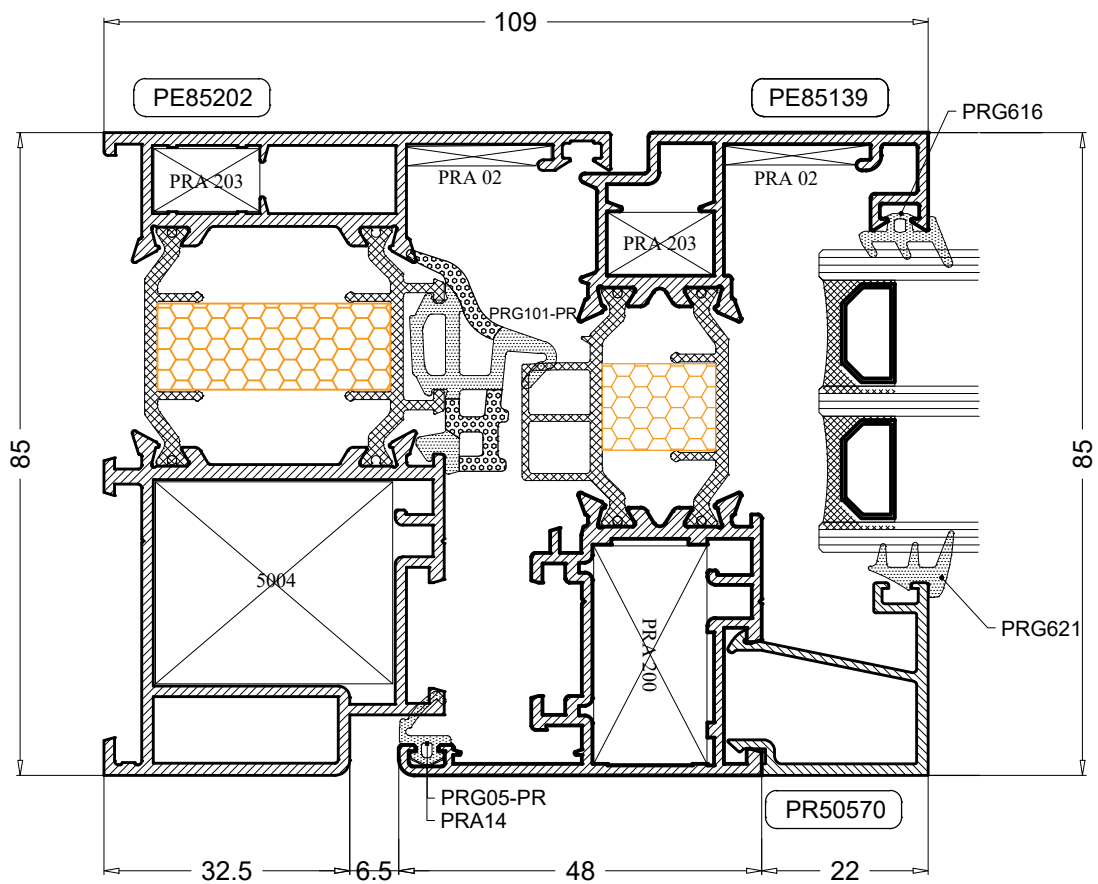
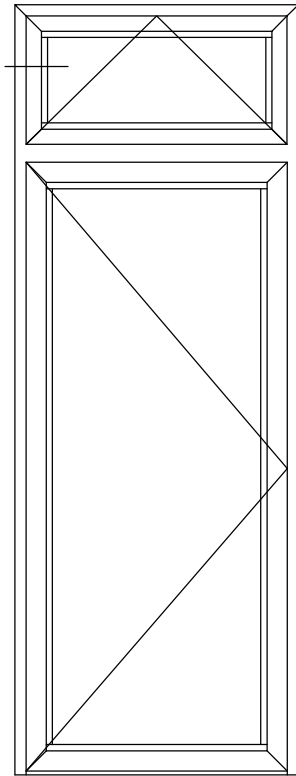

Jednokrilna vrata sa ventusom - Unutarne otvaranje - Uski štok

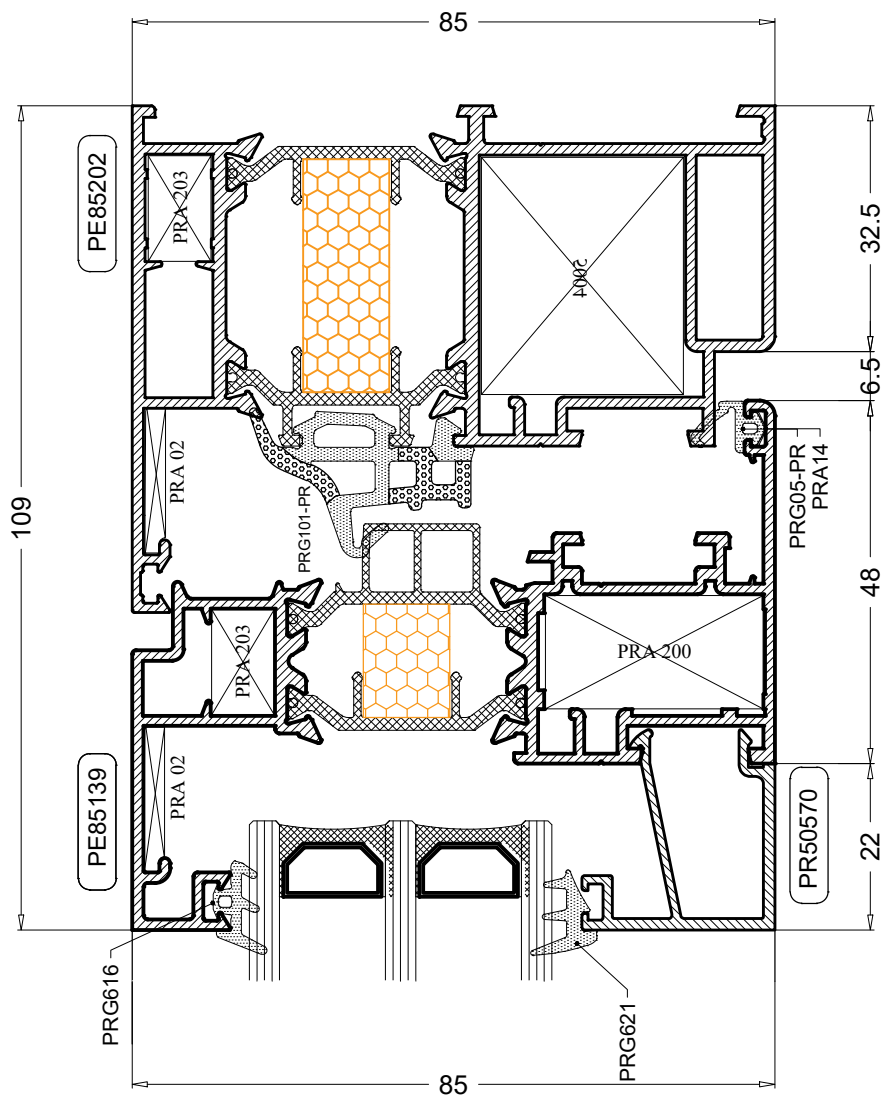
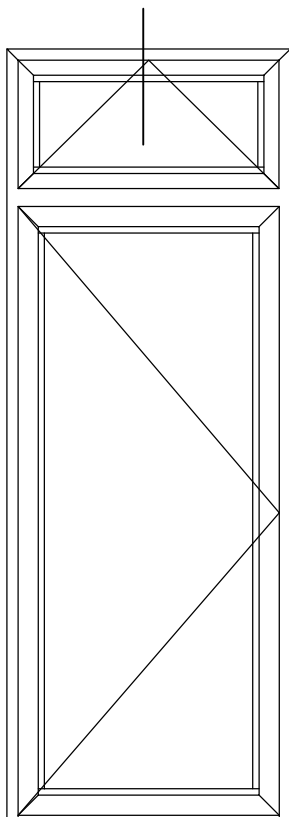

Jednokrilna vrata sa ventusom - Unutarnje otvaranje - Uski štok

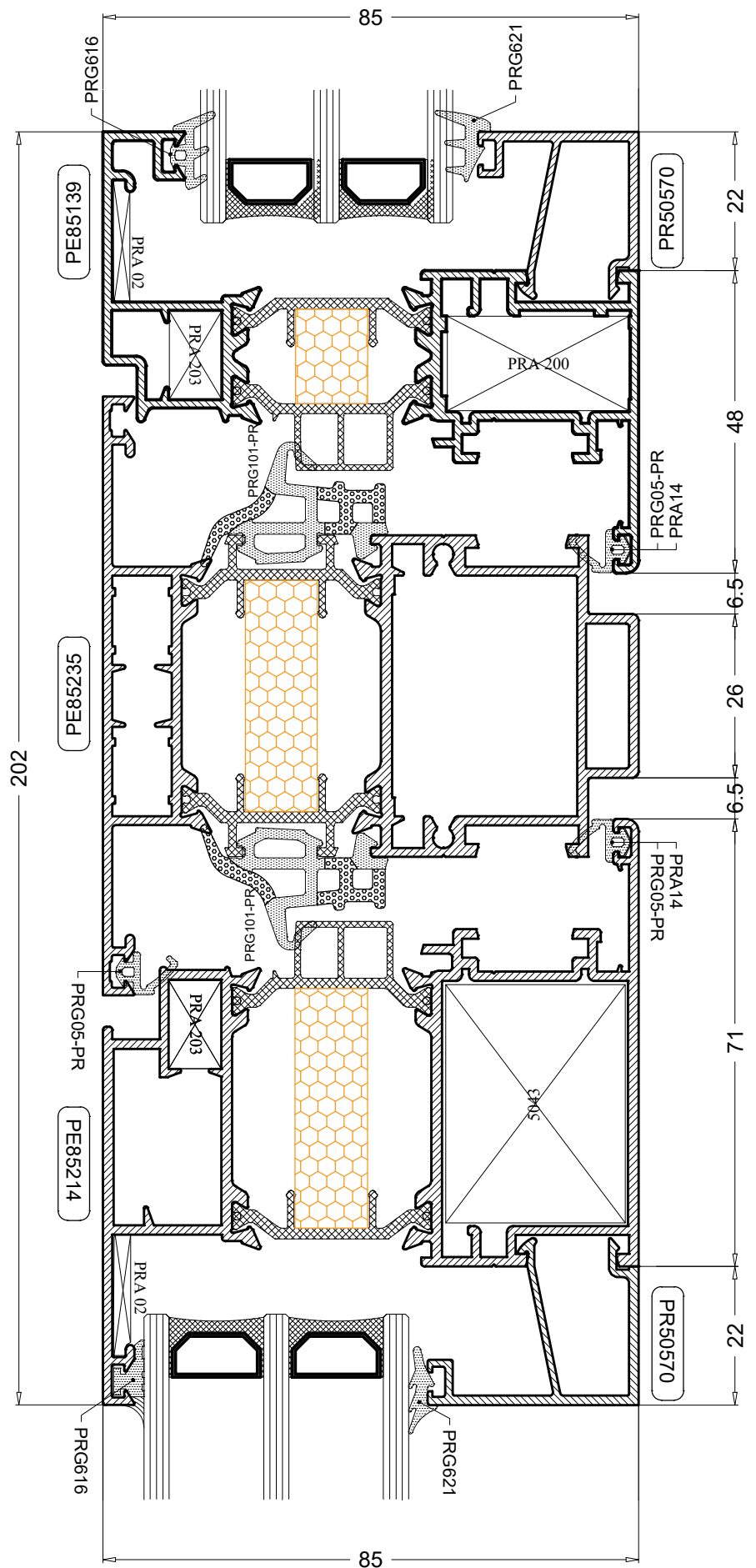
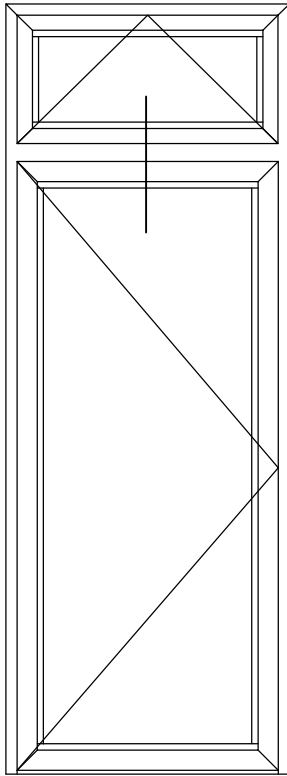



Rezne liste - Jednokrilna vrata/staklo - Veliki okvir

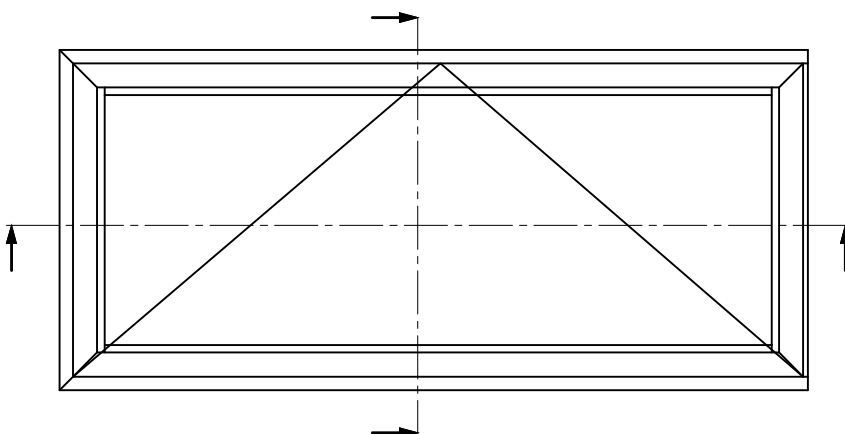
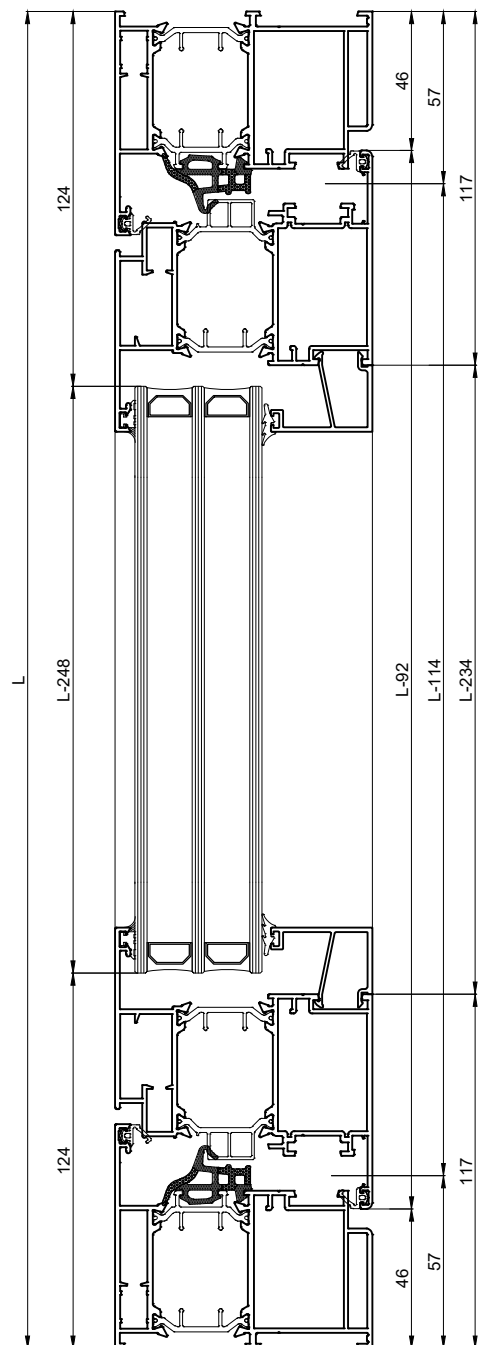
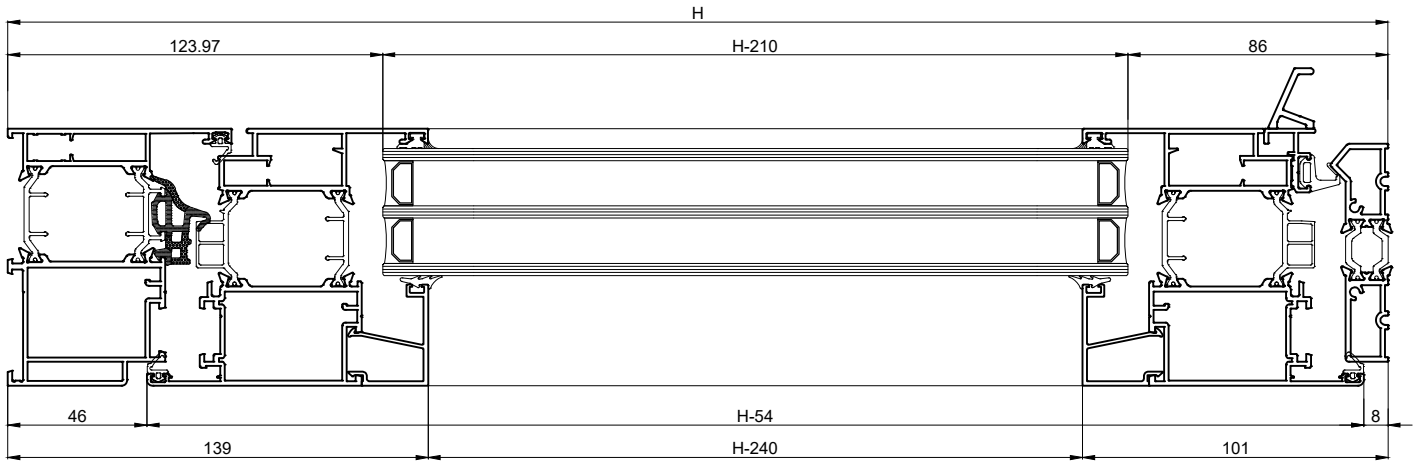

Rezne liste - Jednokrilna vrata/staklo - Veliki okvir

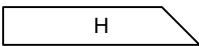
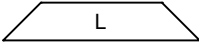
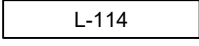
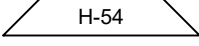
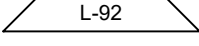
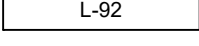
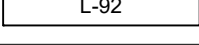
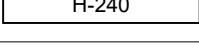
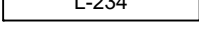
KOD	PROFIL	BR. KOM	REZANJE	KOD	OKOVI	BR. KOM	NOTE
PE 85206	OKOMICA OKVIRA	1L 1D		TONALE 5043	KUTNIK OKVIRA/KRILA	6	
PE 85206	GORNJA VODORAVNICA OKVIRA	1		PRA 02	KUTNIK PORAVNANJA OKVIRA/KRILA	6	
PE 85241	PRAG	1		PRA 203	KUTNIK PORAVNANJA KRILA/OKVIRA	6	
PE 85214	OKOMICA KRILA	1L 1D		PRA 14	KUTNIK PORAVNANJA KRILA/OKVIRA	6	
PE 85214	VODORAVNICA KRILA	2		VILM	VIJAK ZA 5043	12	
PR 58538	NOSAČ BRTVE	1		0092	BOLCNA ZA PRA203	12	
PR 58543	OKAPNICA	1					
-	OKOMITA LAJSNA	2					
-	VODORAVNA LAJSNA	2					

KOD	BRTVE/ČEPOVI	BR. KOM	NOTE
PRG101-PR	CENTRALNA BRTVA	3	1L + 2H
PRA91-PR	KUTNIK CENTRALNE BRTVE	2	-
PRG05-PR	UNUTARNJA BRTVA KRILA	7	3L + 4H
PRG 21	BRTVA PRAGA	1	L
PRG -	VANJSKA BRTVA STAKLA	2	2L + 2H
PRG -	UNUTARNJA BRTVA STAKLA	2	2L + 2H

GORNJA STAKLA		DONJA STAKLA	
(L-248) x (H-210)	1		

Rezne liste - Jednokrilna vrata s panelom - Veliki okvir

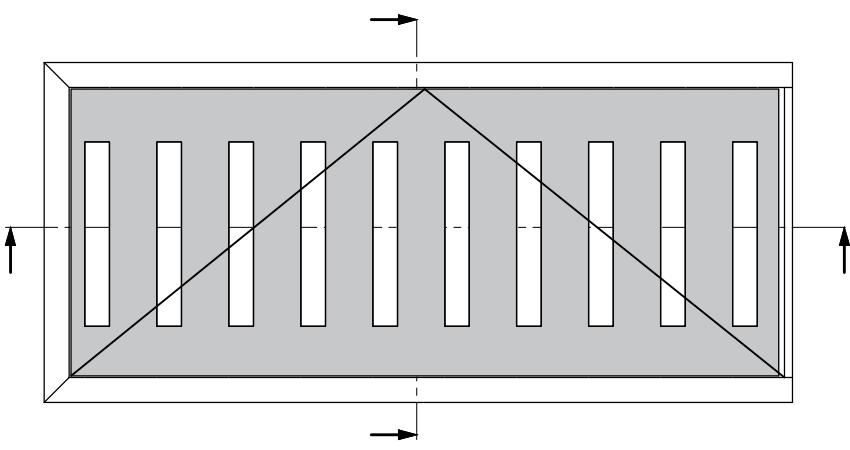
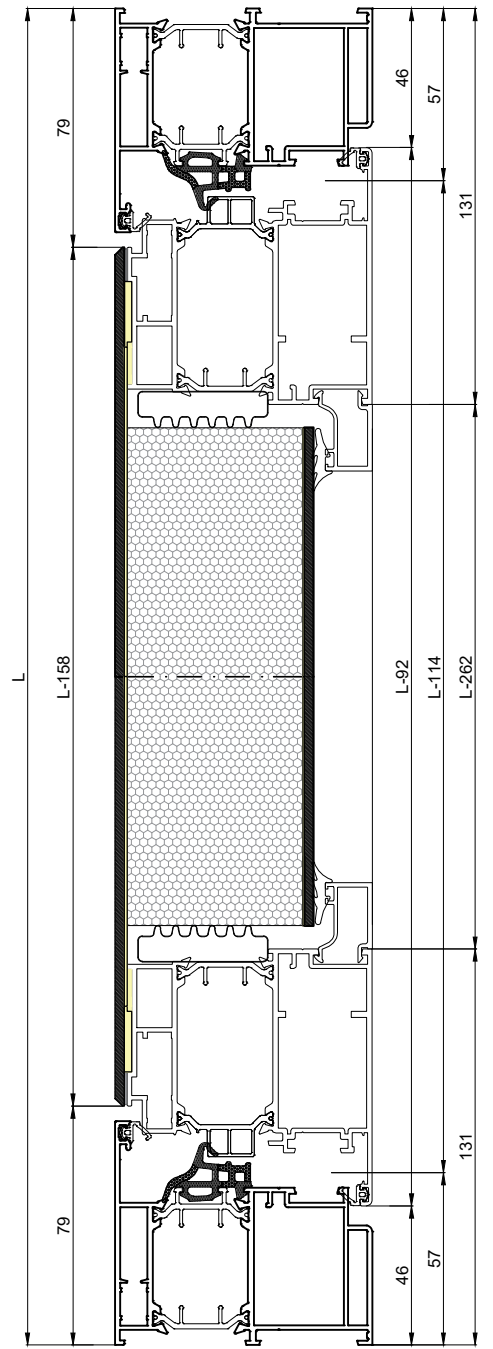
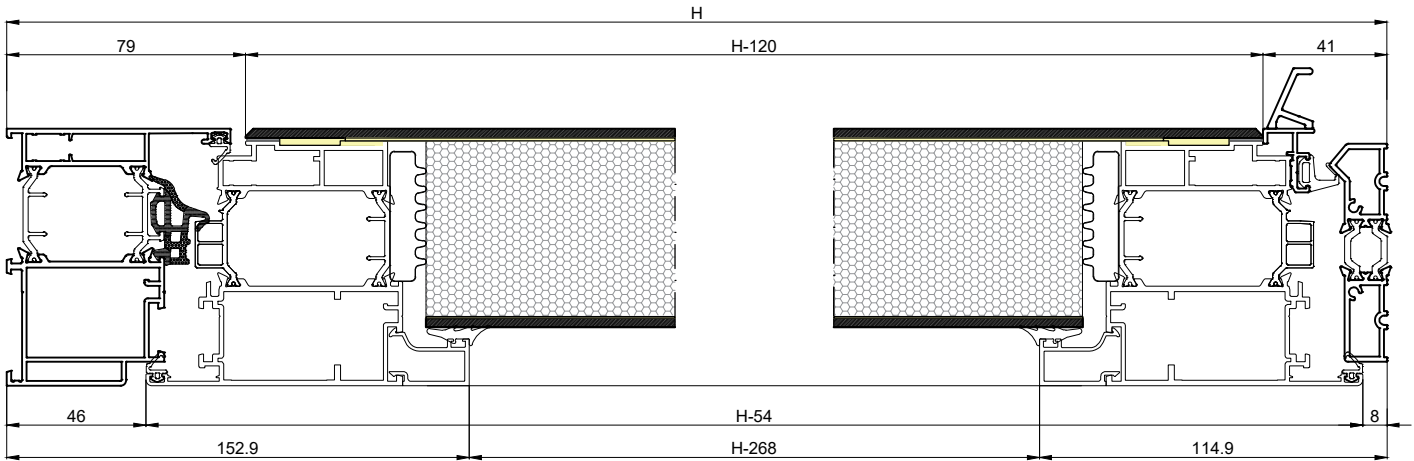

Rezne liste - Jednokrilna vrata - Veliki okvir

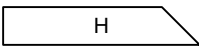
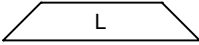
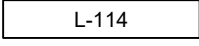
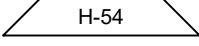
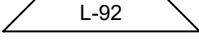
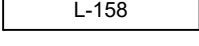
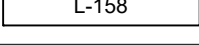
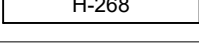
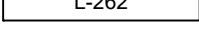
KOD	PROFIL	BR. KOM	REZANJE	KOD	OKOVI	BR. KOM	NOTE
PE 85206	OKOMICA OKVIRA	1L 1D		TONALE 5043	KUTNIK OKVIRA	2	
PE 85206	GORNJA VODORAVNICA OKVIRA	1		PRA 204	KUTNIK KRILA	4	
PE 85241	PRAG	1		PRA 02	KUTNIK PORAVNANJA OKVIRA/KRILA	2	
PE 85242	OKOMICA KRILA	1L 1D		PRA 203	KUTNIK PORAVNANJA KRILA/OKVIRA	6	
PE 85242	VODORAVNICA KRILA	2		PRA 14	KUTNIK PORAVNANJA KRILA/OKVIRA	6	
PR 58538	NOSAČ BRTVE			0126	KUTNIK PORAVNANJA KRILA	4	
PR 58543	OKAPNICA	1		VILM	VIJAK ZA 5043/PRA204	12	
-	OKOMITA LAJSNA	2		0092	BOLCNA ZA 0126 i PRA203	12	
-	VODORAVNA LAJSNA	2					

KOD	BRTVE/ČEPOVI	BR. KOM	NOTE
PRG101-PR	CENTRALNA BRTVA	3	1L + 2H
PRA91-PR	KUTNIK CENTRALNE BRTVE	2	-
PRG05-PR	UNUTARNJA BRTVA KRILA	7	3L + 4H
PRG 21	BRTVA PRAGA	1	L
PRG -	VANJSKA BRTVA STAKLA	2	2L + 2H
PRG -	UNUTARNJA BRTVA STAKLA	2	2L + 2H

VANJSKI PANEL		UNUTARNJI PANEL	
(L-158) x (H-120)	1	(L-277) x (H-239)	1

Obrada na profilu PE85110 i PE85139 za montiranje kutnika PRA200 i PRA 203

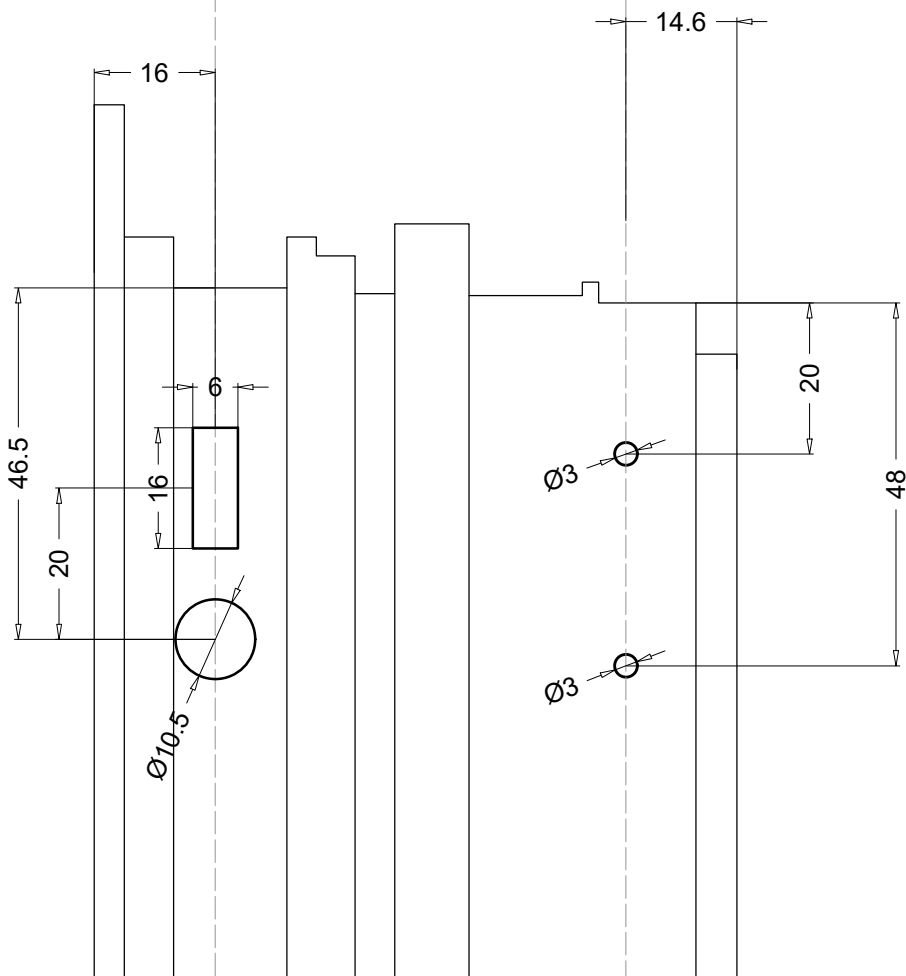
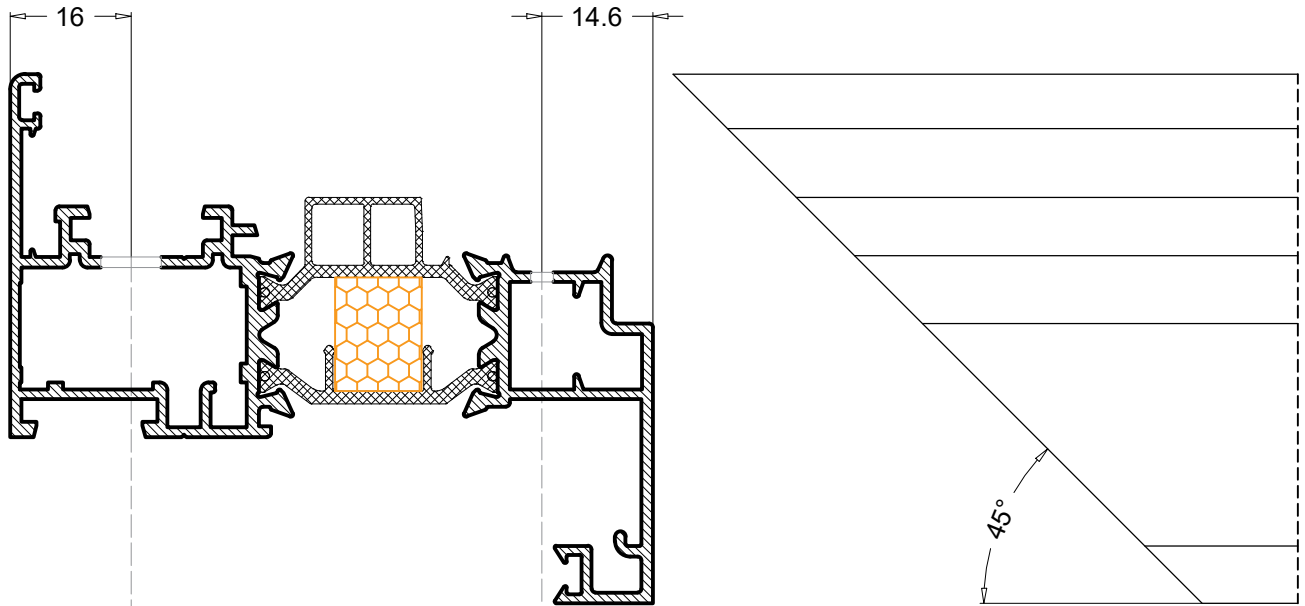

Obrada na profilu PE85202 za montiranje kutnika 5004 i PRA 203

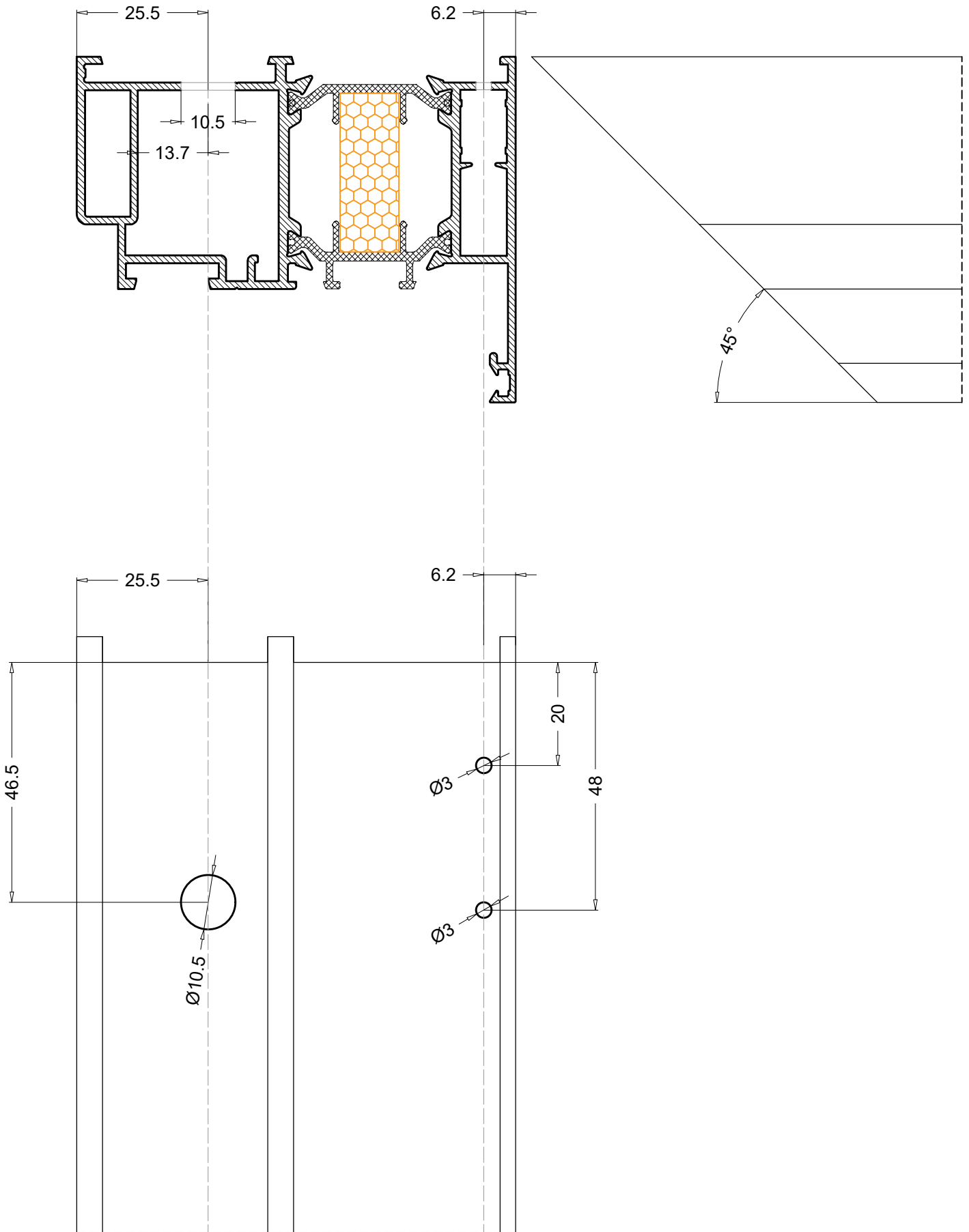

Obrada na profilu PE85206 za montiranje kutnika 5043 i PRA 203

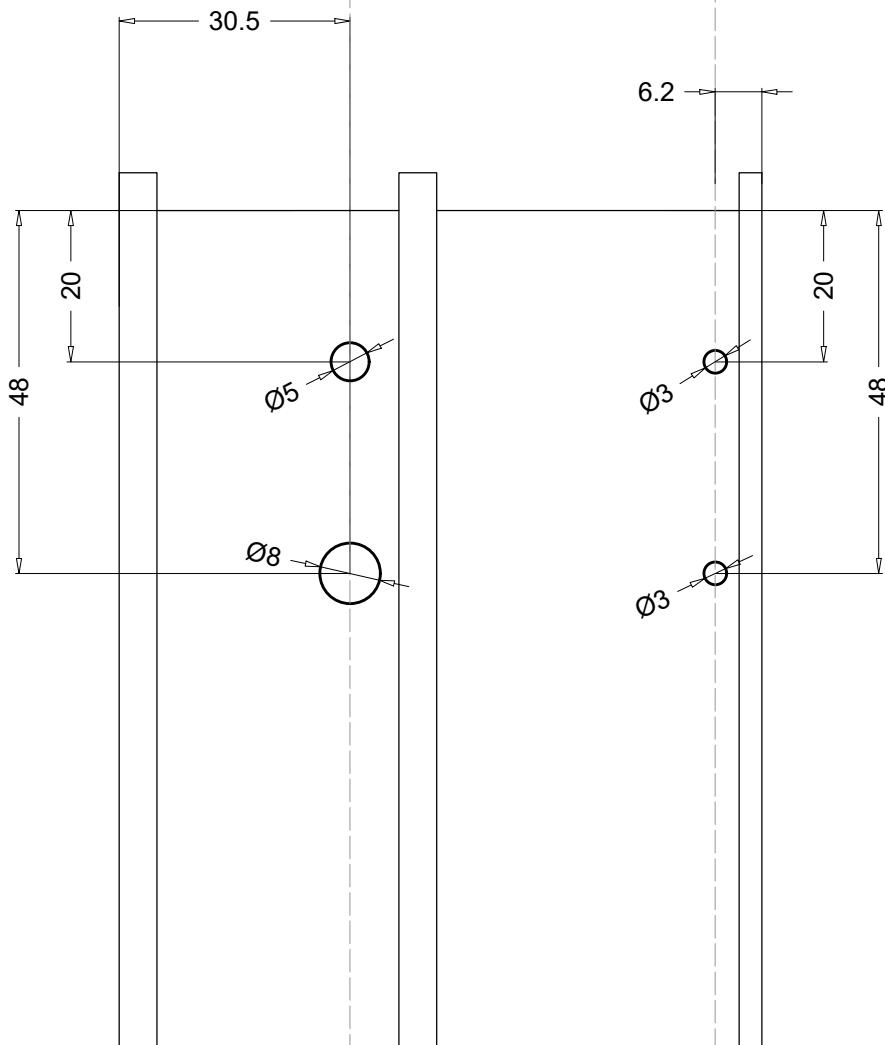
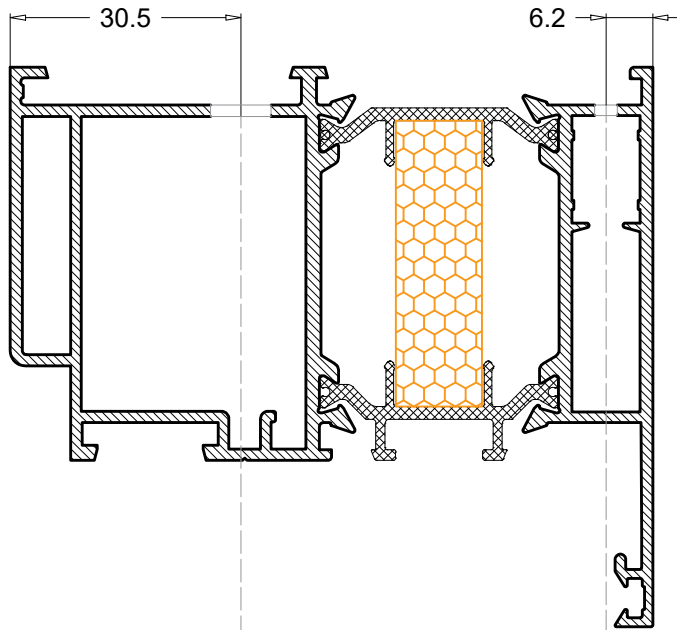

Obrada na profilu PE85214 za montiranje kutnika 5043 i PRA 203

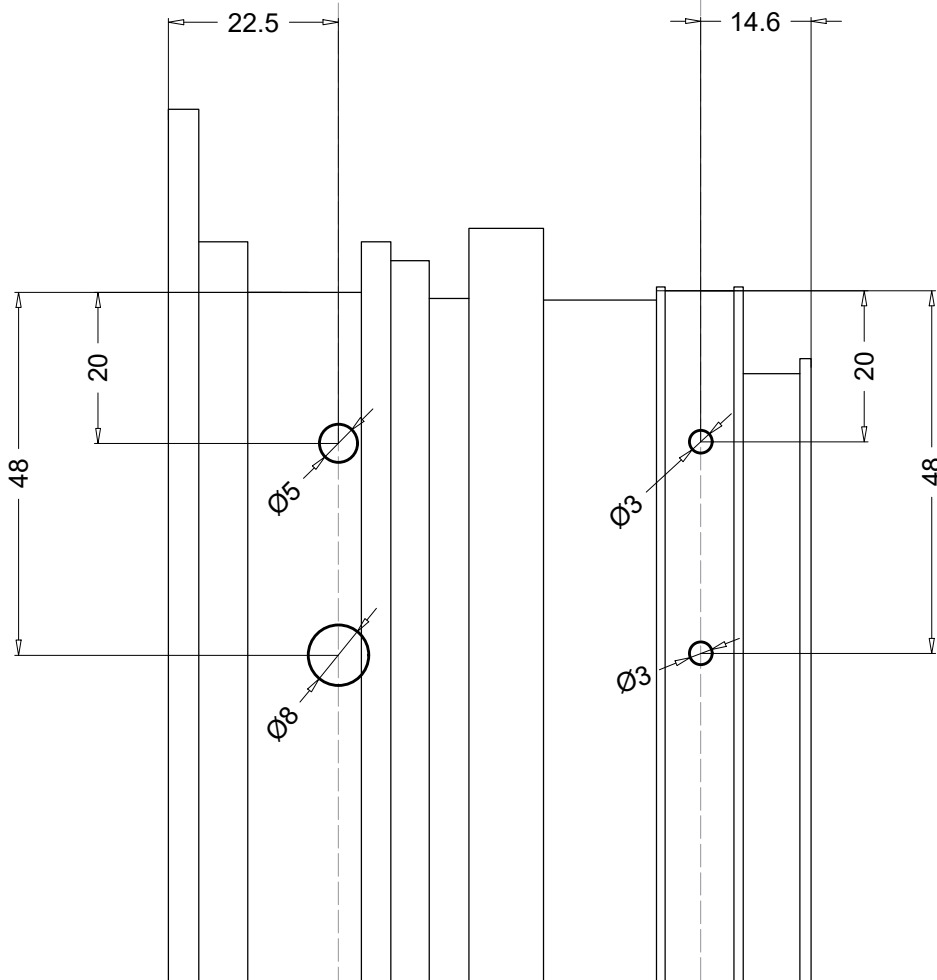
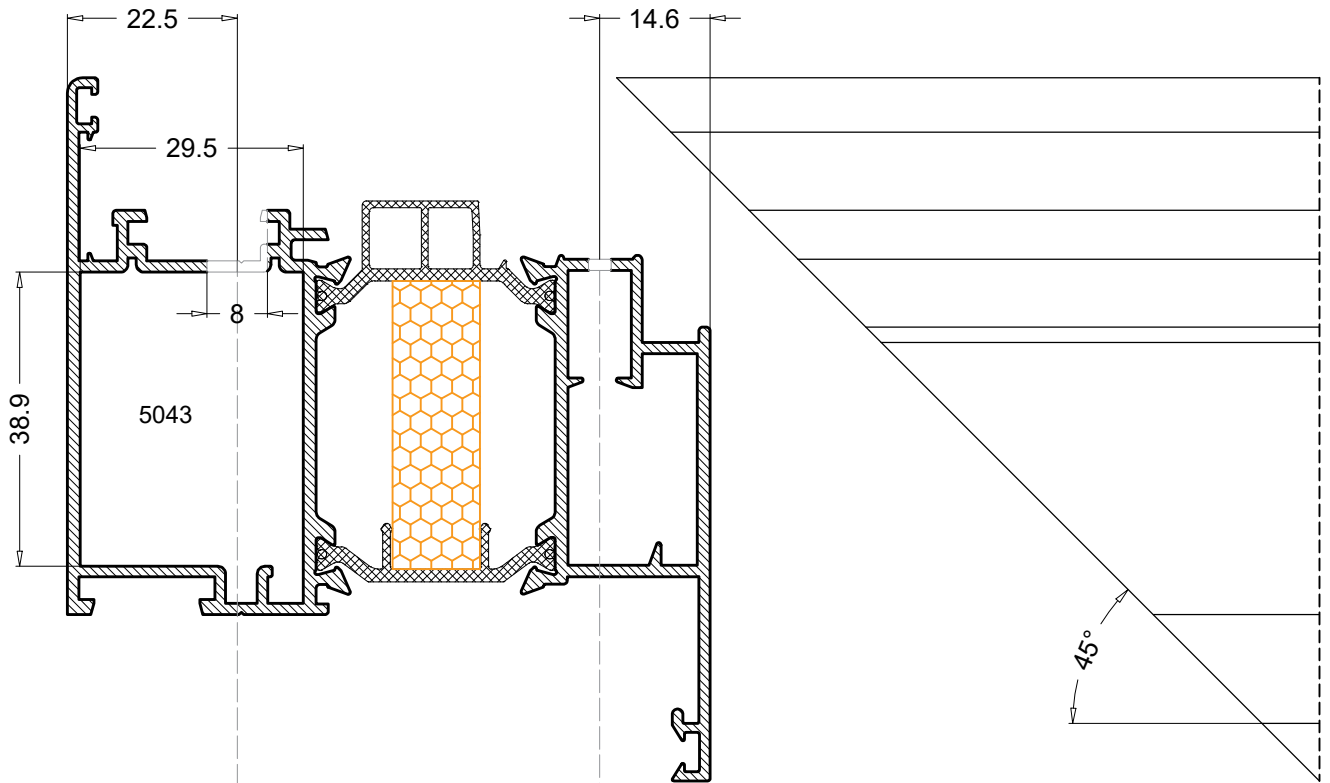



Obrada na profilu PE85242 za montiranje kutnika PRA204 i 0126

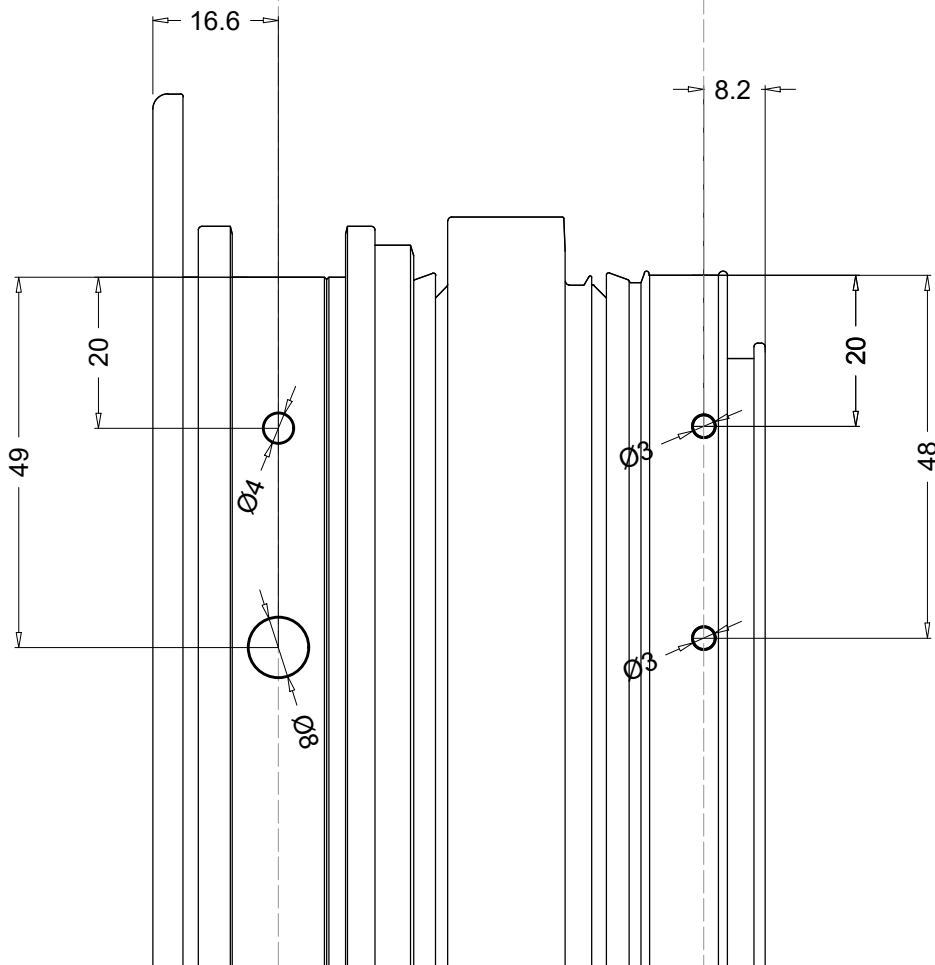
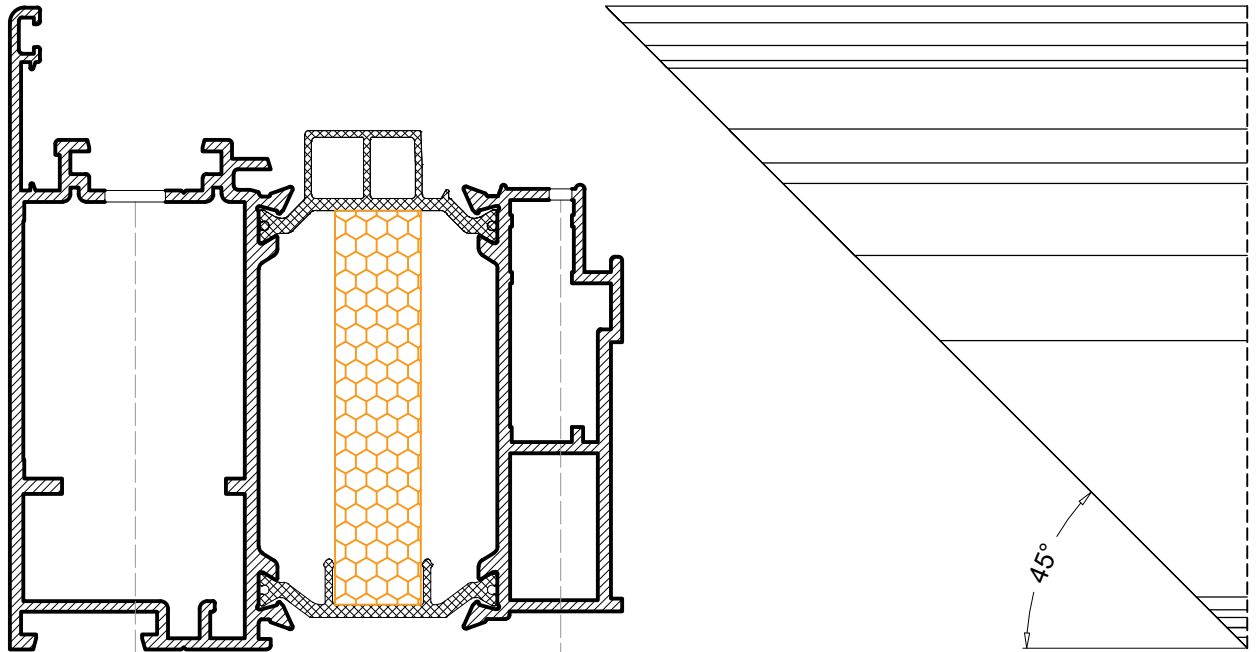

Obrada na profilu klizača PR50550

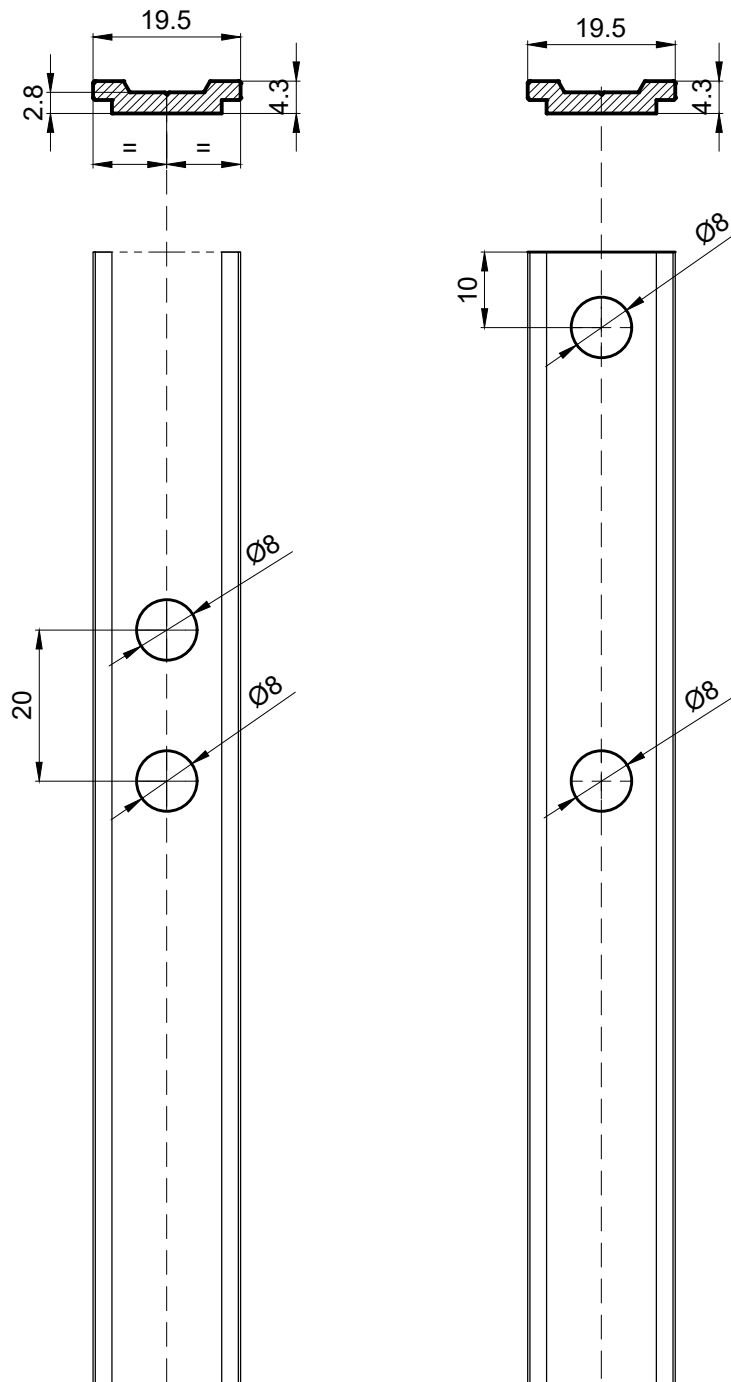

Obrada na profilu okvira za odvod kondenza

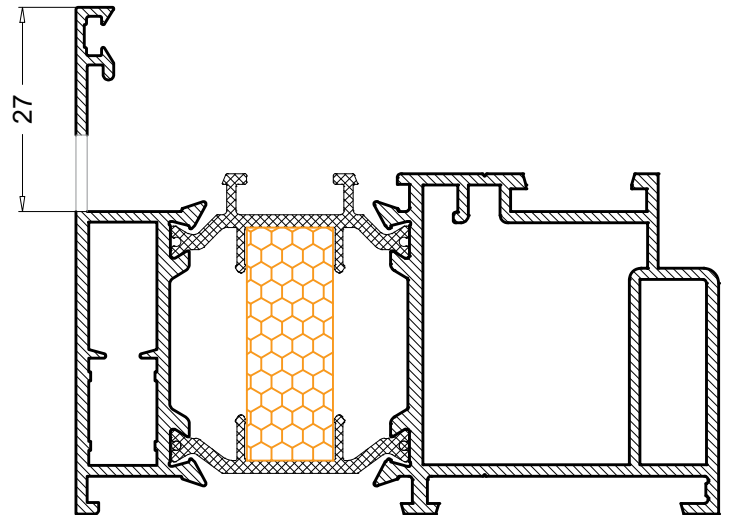
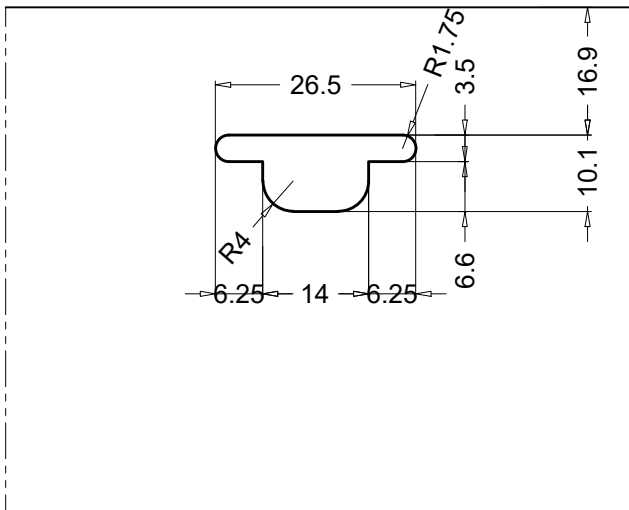

Obrada na profilu okvira za spajanje s pragom

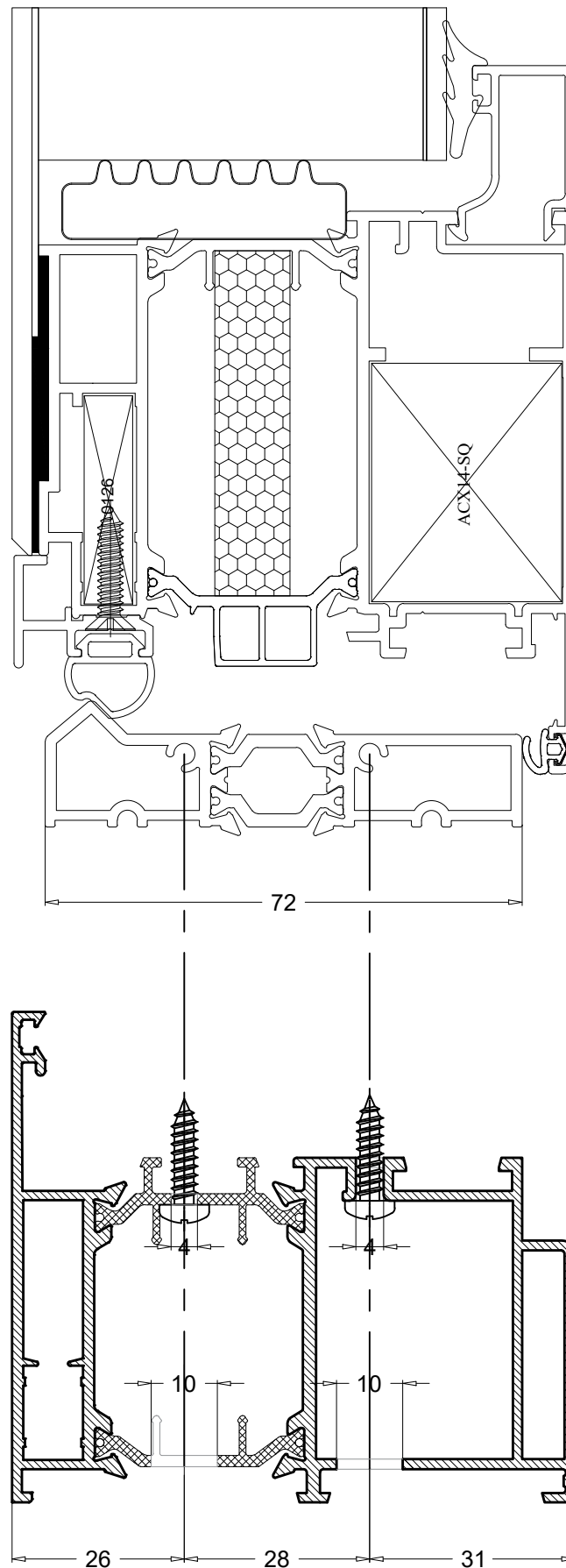

Obrada na profilu PE85235 za spajanje s okvirom

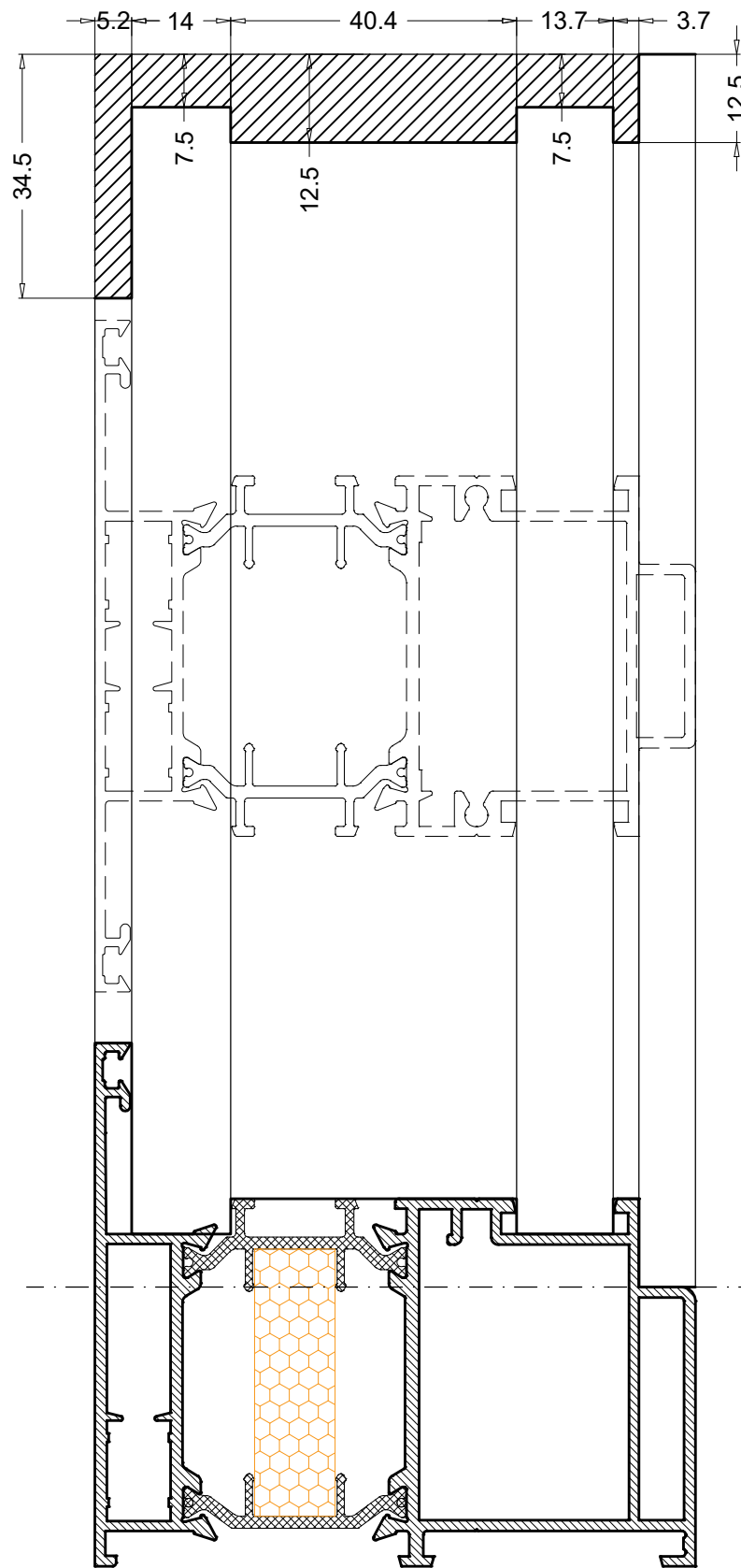

PE85235

PE85206



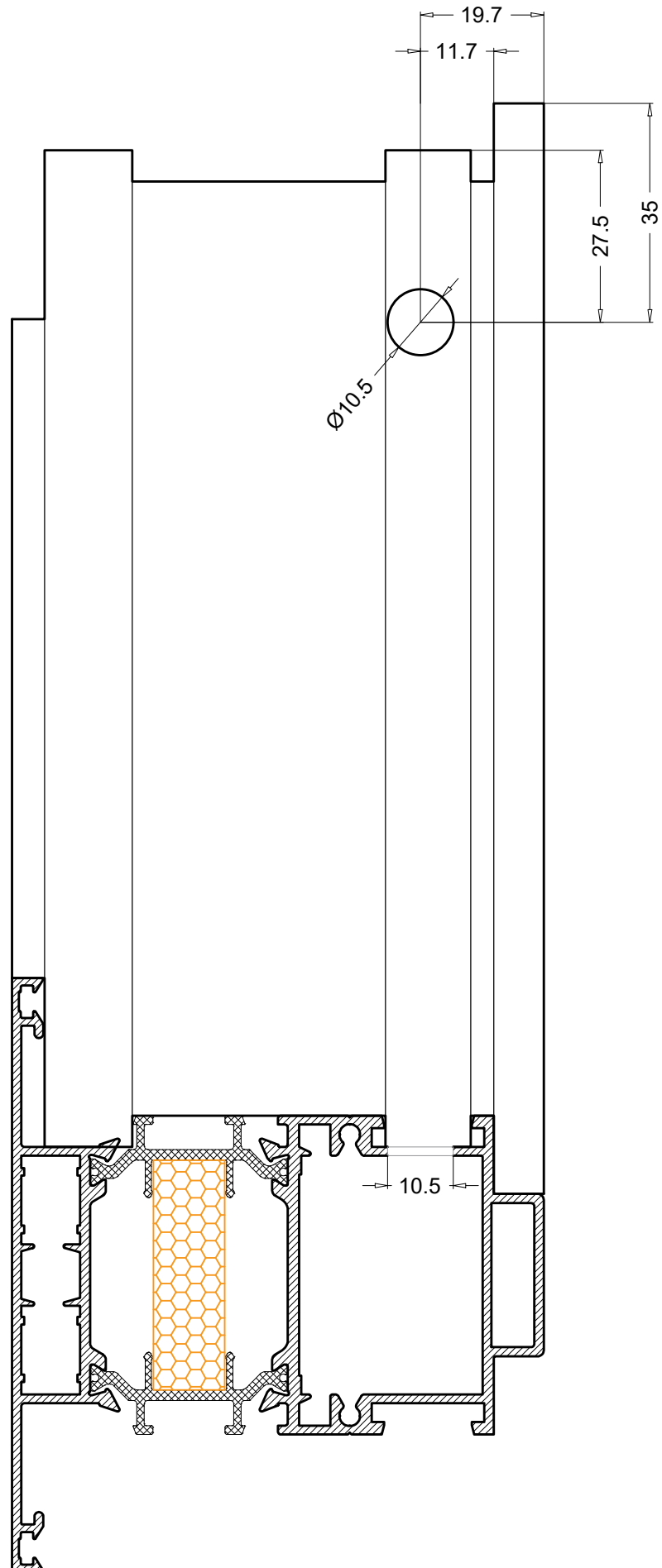



Obrada na profilu PE85235 za spajanje veznikom G123



**OKOVI**

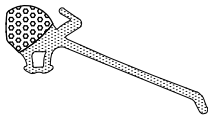

Code Kod	Section Presjek	Description Opis	Box Quantity Količina/pak.			Material Materijal		
PRG101		CENTRALNA BRTVA	60			EPDM + ESPANSO		
PRA91		KUTNIK CENTRALNE BRTVE PRG101	60 (komada)			EPDM		
UP2		UNUTARNJA EPDM BRTVA ZA STAKLO, 2 mm	180			EPDM		
PRG621		UNUTARNJA EPDM BRTVA ZA STAKLO, 2-3 mm	160			EPDM		
UP4		UNUTARNJA BRTVA ZA STAKLO 4mm	???			EPDM		
PRG14		UNUTARNJA EPDM BRTVA ZA STAKLO, 4-5 mm	120			EPDM		
PRG705		UNUTARNJA EPDM BRTVA S PEROM ZA STAKLO, 4-5 mm	150			EPDM		
PRG17		UNUTARNJA EPDM BRTVA ZA STAKLO, 6-7 mm	80			EPDM		

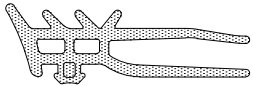
OKOVI



Code Kod	Section Presjek	Description Opis	Box Quantity Količina/pak.			Material Materijal		
PRG602		VANJSKA KOEKSTRUDIRANA BRTVA ZA STAKLO, 2 mm	350			EPDM + ESPANSO		
			E65Stt	E50	E50tt	PR65tt	PE85tt	PK150tt
PRG603		VANJSKA KOEKSTRUDIRANA GUMA ZA STAKLO, 3 mm	250			EPDM + ESPANSO		
			E65Stt	E50	E50tt	PR65tt	PE85tt	PK150tt
PRG604		VANJSKA KOEKSTRUDIRANA BRTVA ZA STAKLO, 3 mm	200			EPDM + ESPANSO		
			E65Stt	E50	E50tt	PR65tt	PE85tt	PK150tt
PRG610		VANJSKA KOEKSTRUDIRANA BRTVA S PEROM ZA STAKLO, 3 mm	100			EPDM + ESPANSO		
			E65Stt	E50	E50tt	PR65tt	PE85tt	PK150tt
PRG616		VANJSKA BRTVA ZA STAKLO 2-3mm	-			EPDM		
			E65Stt	E50	E50tt	PR65tt	PE85tt	PK150tt
PRG617		VANJSKA EPDM BRTVA ZA STAKLO, 3-4 mm	-			EPDM		
			E65Stt	E50	E50tt	PR65tt	PE85tt	PK150tt
PRG618		VANJSKA EPDM BRTVA ZA STAKLO, 4-5 mm	150			EPDM		
			E65Stt	E50	E50tt	PR65tt	PE85tt	PK150tt
PRG620		VANJSKA EPDM BRTVA SA USNAMA ZA STAKLO, 5 mm	150			EPDM		
			E65Stt	E50	E50tt	PR65tt	PE85tt	PK150tt

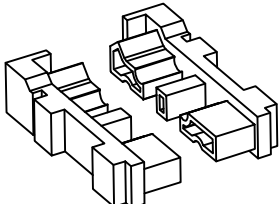

OKOVI

Code Kod	Section Presjek	Description Opis	Box Quantity Količina/pak.			Material Materijal		
PRG05-PR		UDARNA EPDM BRTVA	200			EPDM		
			E50	E50tt	PR65tt	PE85tt		
PRG05-PR- CO		UDARNA KOEKSTRUDIRANA BRTVA	240			EPDM + ESPANSO		
			E50	E50tt	PR65tt	PE85tt		
PRG21		BRTVA PRAGA PE85tt i PR65tt				EPDM		
						PR65tt	PE85tt	
PRG85		Čep za prag PE85tt				PVC		
							PE85tt	

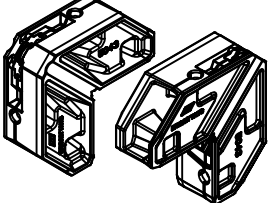
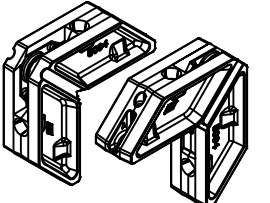
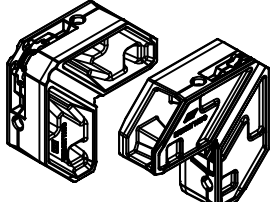
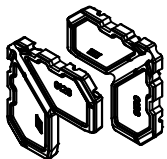
OKOVI

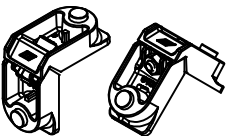
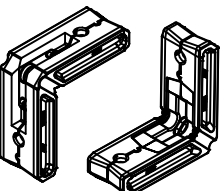
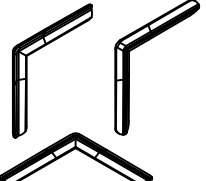
KOD	OPIS	Komada po pakovanju	MATERIJAL						
5043	 Tonale kutnik 29 mm x 38.5 mm						PE85tt		
5004	 Tonale kutnik 26.8 mm x 31.4 mm						PE85tt		
PRA204	 Tonale kutnik 28,6 mm x 36 mm						PE85tt		
0126	 Kutnik 7.3 mm x 31.4 mm						PE85tt		
PRA02	 Kutnik poravnanja pokretnog krila 4.8mm x 17.4 mm			PR65tt	PE66tt	PE75tt	PE85tt	PK150tt	
PRA200	 Kutnik sa dugmetom 28.5 mm x 14.5 mm			PR65tt	PE66tt	PE75tt	PE85tt	PK150tt	
5011	 Tonale kutnik 28.5 mm x 14.5 mm			PR65tt	PE66tt	PE75tt	PE85tt	PK150tt	
PRA 14	 Kutnik poravnanja štoka/krila			PS50	SO49tt	PR65tt	PE66tt	PE75tt	PE85tt

OKOVI

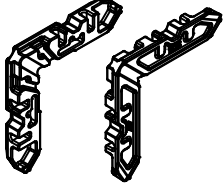
KOD	OPIS	Komada po pakovanju	MATERIJAL
PRA 203	 <p>Kutnik poravnanja štoka/kрила</p>		<p>Aluminijski odlivak</p> <p>PE85tt</p>

## NAPOMENE