





- › STAKLENA OGRADA
- › VIEW CRYSTAL

CJENOVNIK

R.b.	Slika	Šifra	EAN code	Naziv	jm	Cijena bez PDV	Cijena sa PDV
1.		38729	8551	CORT BOCNA MASKA PROFILA S1 L-6_1	kom		
2.		38728	8552	CORT BOCNI PROFIL OGRADE S1 L-6_1	kom		
3.		30510	8553	CORT PROFIL ZA GORNJU MONTAZU S1	kom		
4.		30511	8562	CORT RUKOHVAT ZA 8+8 S1	kom		
5.		38722	348501	CORT GUMA VANJSKA ZA OGRADU	met		
6.		30512	348502	CORT GUMA UNUTRASNJA 11mm	met		
7.		38723	348510	CORT KLIN ZA OGRADU ZA STAKLO 12,76 mm	kom		
8.		38732	348514	CORT KLIN ZA OGRADU ZA STAKLO 16,76 mm	kom		
9.		38724	348518	CORT KLIN ZA OGRADU ZA STAKLO 20,76 mm	kom		
10.		30513	348555	CORT BOCNI POKLOPAC NOSAC 8553	kom		
11.		38725	348565	CORT BOCNA POKLOPAC DESNI	kom		
12.		38726	348575	CORT BOCNA POKLOPAC LIJEVI	kom		
13.		30514	408521	CORT VANJSKI PODMETAC STAKLA	kom		

VIEW CRYSTAL

Tehnička rješenja za estetske zahtjeve
The technical solutions for aesthetic requirements

ESTETIKA
SIGURNOST
KVALITET

AESTHETICS
SECURITY
QUALITY





▶ VIEW CRYSTAL



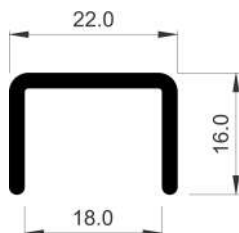

COR-8562	
Opis Description	Završna obrada stakla 8.8 Glass finishing 8.8
Težina Weight (g/m)	261,9
Površina Surface (dm ² /m)	9,97
Ix (cm⁴)	0,24
Iy (cm⁴)	0,7

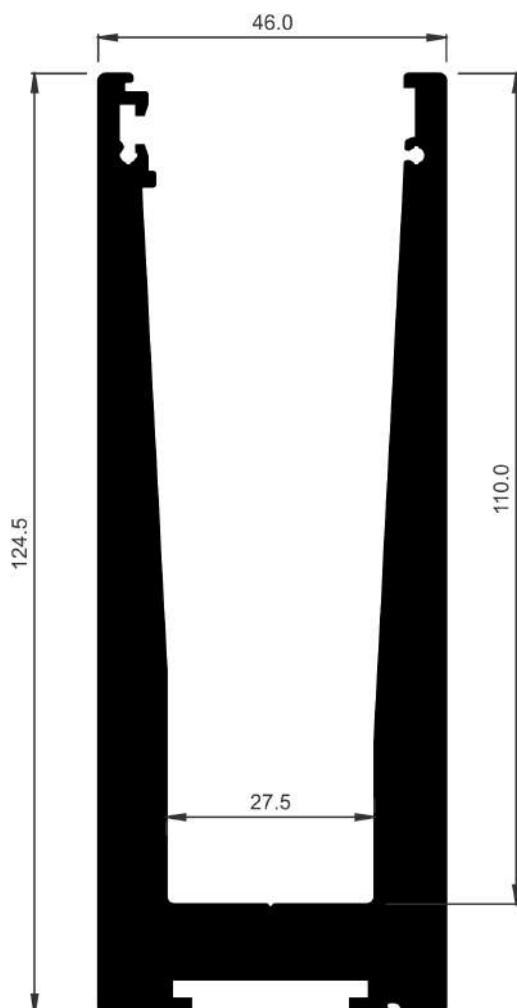

COR-8550	
Opis Description	Staklena ograda za montažu sa gornje strane Balustrade bottom support
Težina Weight (g/m)	5942,7
Površina Surface (dm ² /m)	60,11
Ix (cm⁴)	275,71
Iy (cm⁴)	71,84
Zapažanja Observations	Dužina profila 6,1 m bez obrade 6,1 profile without machining

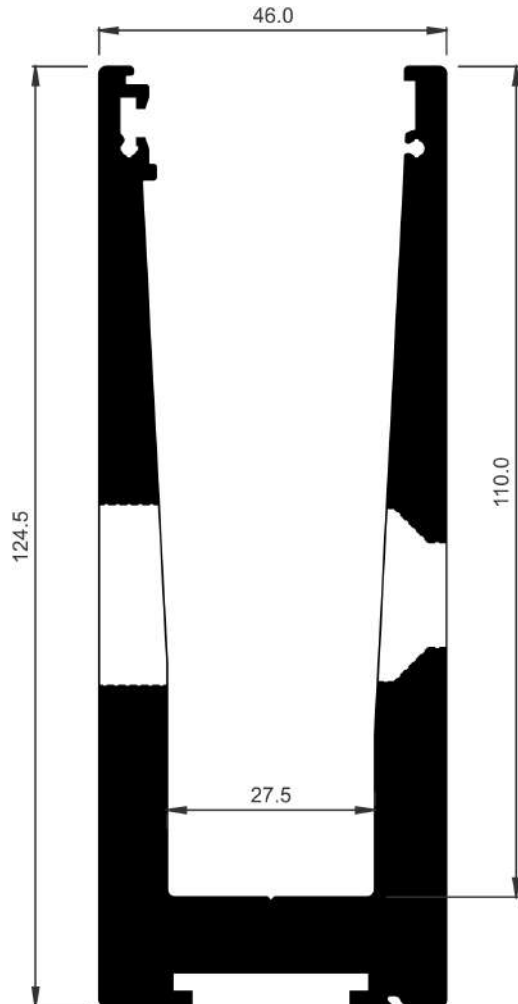

COR-8552	
Opis Description	Soporte inferior barandilla 1 kN Balustrade bottom support 1 kN
Težina Weight (g/m)	5942,7
Površina Surface (dm ² /m)	60,11
I_x (cm ⁴)	275,71
I_y (cm ⁴)	71,84
Zapažanja Observations	Perfil de 6.1 m mecanizado c/250 mm para montaje a canto de forjado 6,1m perfil obraden u rasponu 250mm za bočnu montažu

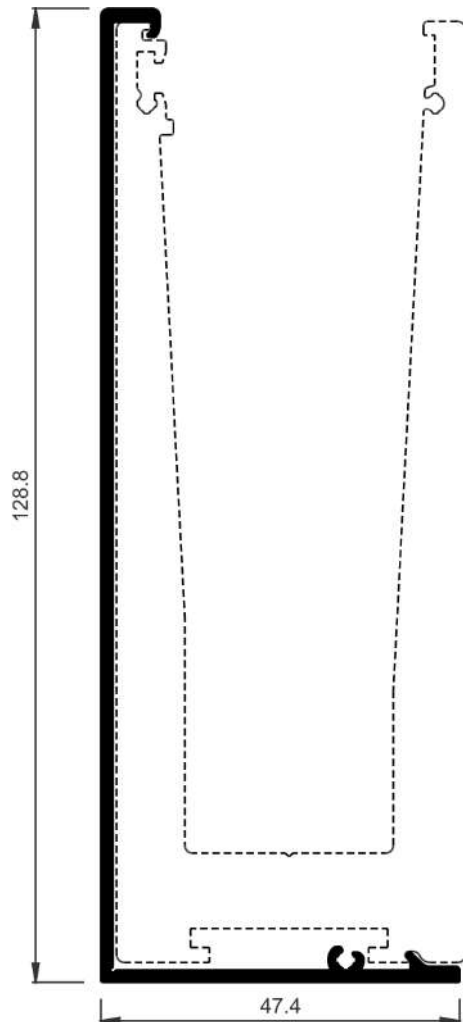

COR-8551	
Descripción Description	Tapa lateral Lateral cover
Peso Weight (g/m)	823,5
Superficie Surface (dm ² /m)	38,41
Ix (cm⁴)	61,03
Iy (cm⁴)	5,44

E 1:1

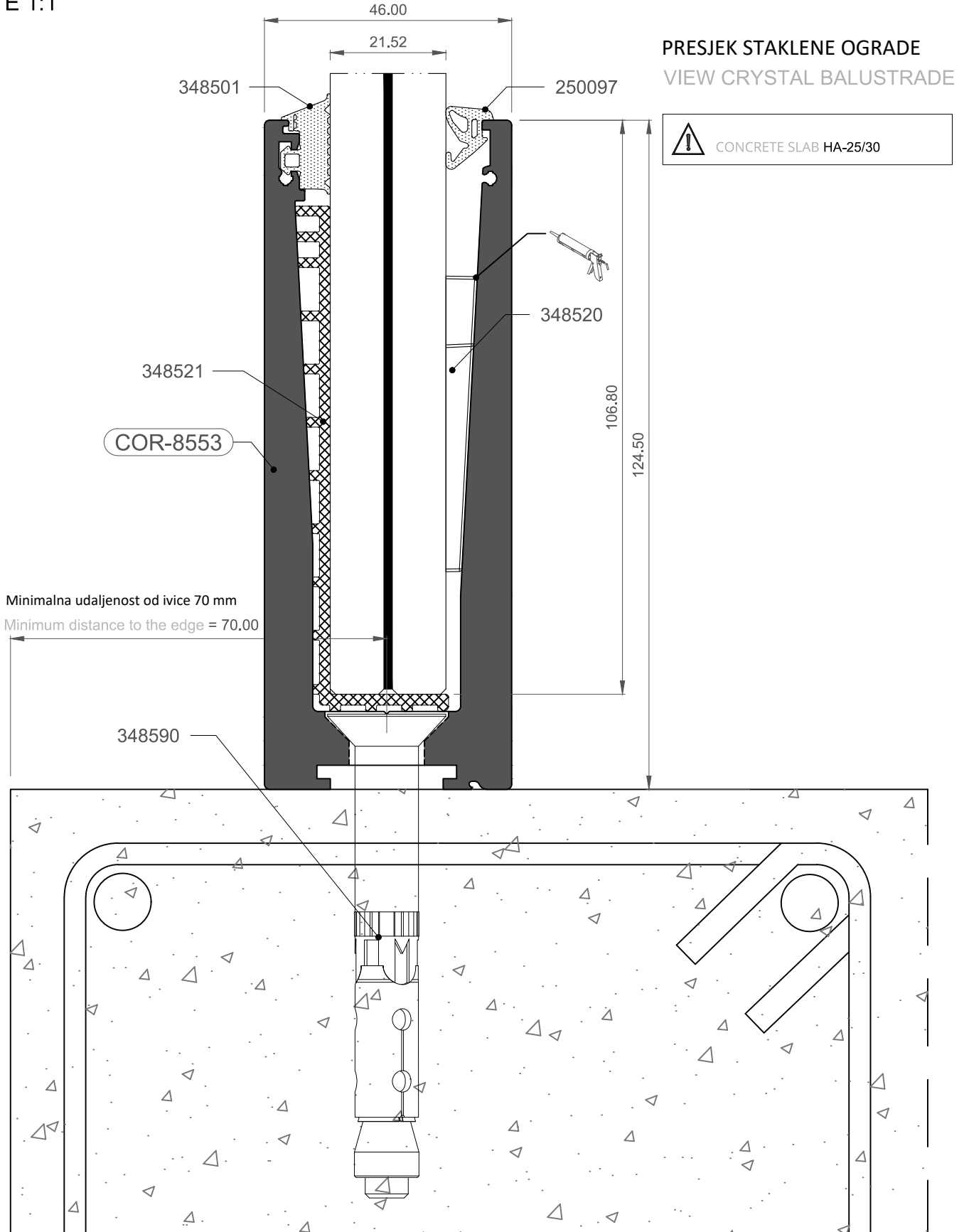

E 1:1

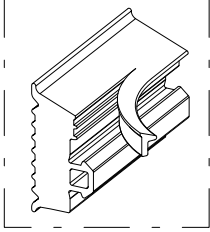



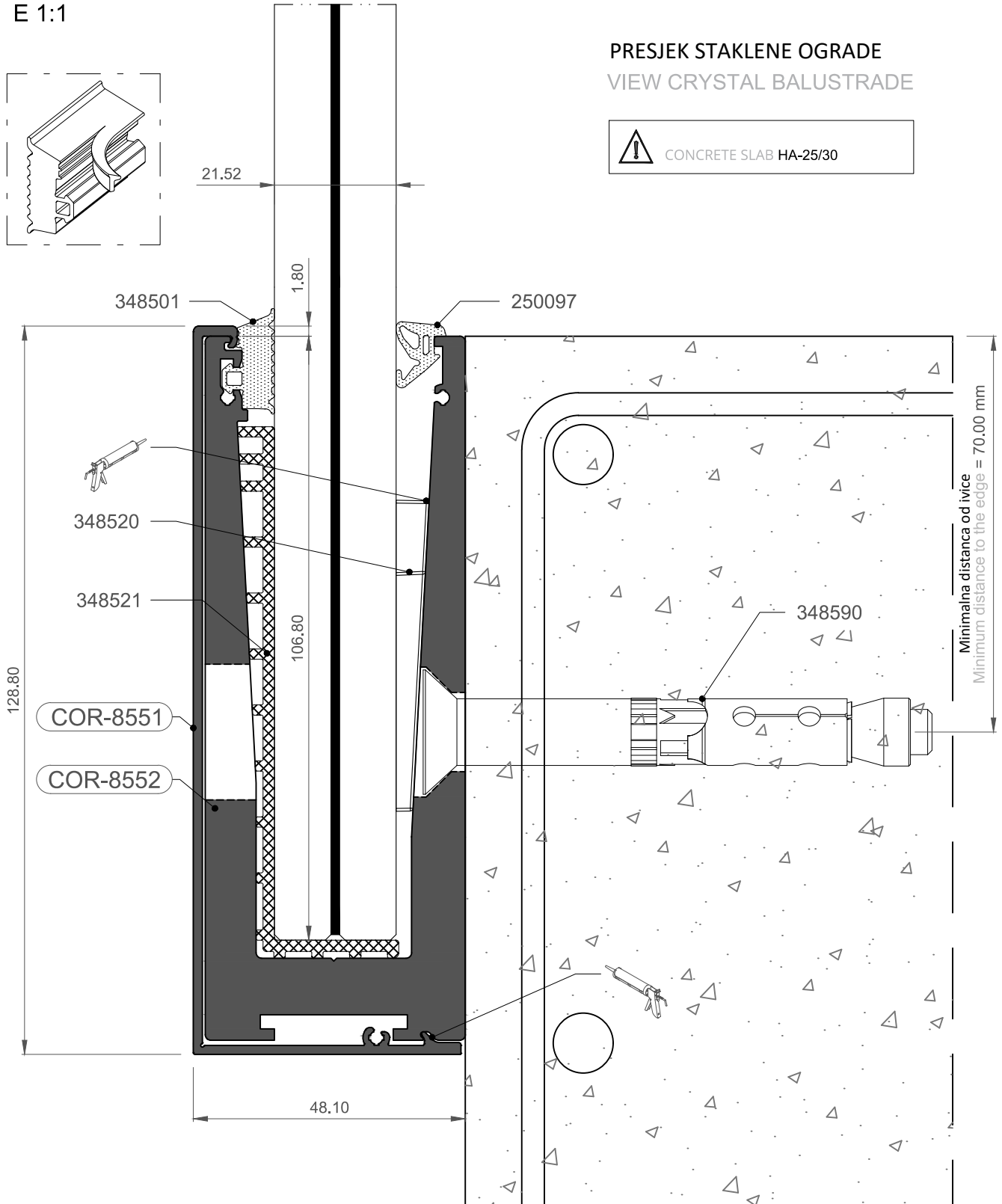

PRESJEK STAKLENE OGRADE
VIEW CRYSTAL BALUSTRADE



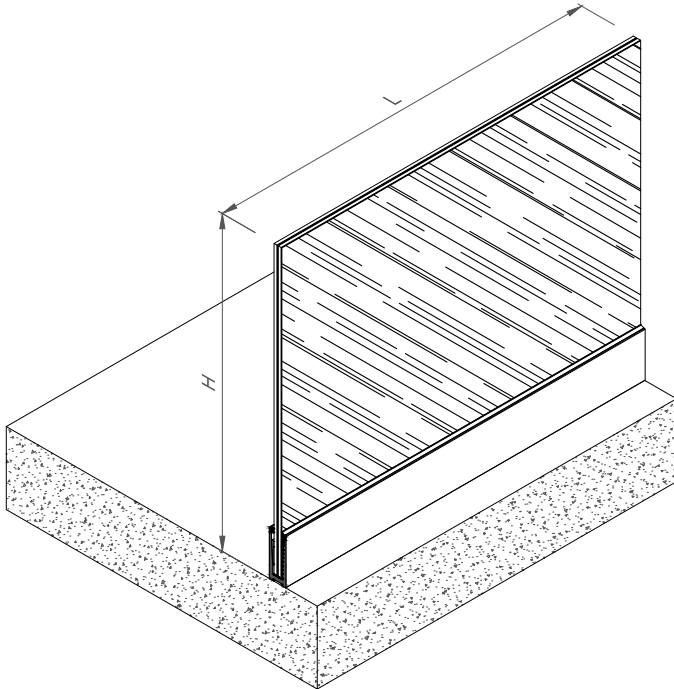

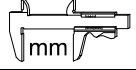

 CONCRETE SLAB HA-25/30



POGLED NA STAKLENU OGRADU PREKO PRESJEKA PLOČE
VIEW CRYSTAL BALUSTRADE OVER SLAB CUTTING SECTION



		
COR-8553	 x 1	L

	348520	1+L/250		348501	L
	348521*	1+L/250		250097	L
	348590	1+L/150			
	348555	x2			

*For LED balustrade use wedge 398531 and diffuser 398530





	e=21.52mm	x 1	Hv = H-17.7 Hv = H-24.0**
---	-----------	-----	------------------------------



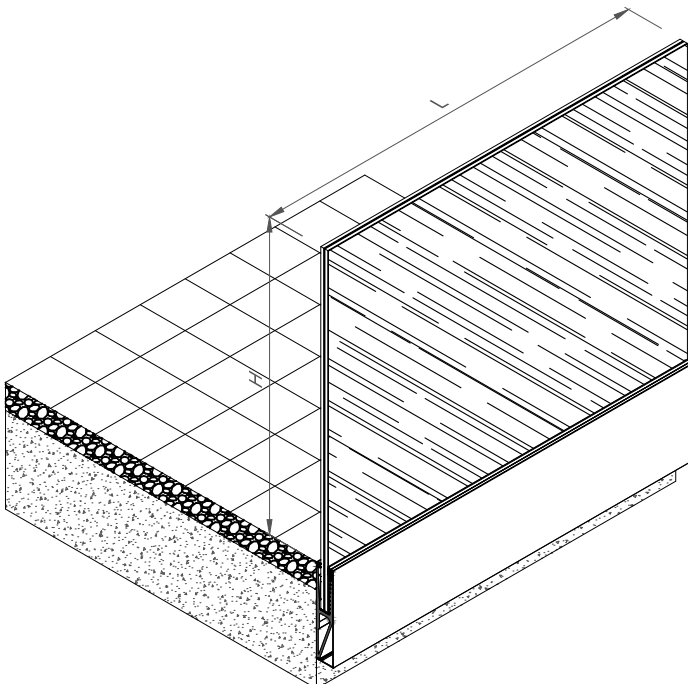



**Height with wedge 398531

POGLED NA STAKLENU BOČNU OGRADU PREKO PRESJEKA PLOČE

VIEW CRYSTAL BALUSTRADE FLUSH ON SLAB EDGE CUTTING SECTION



		
COR-8567	 x 1	L
COR-8564	 x 1	L

	348520	1+L/250		348501	L
	348521*	1+L/250		250097	L
	348592	1+L/300			
	368545	x 1			
	368555	x 1			

*For LED balustrade use wedge 398531 and diffuser 398530

	e=21.52mm	x 1	Hv = H + 106.8 Hv = H + 100.5**
---	-----------	-----	------------------------------------

**Height with wedge 398531

HEMA POSTAVLJANJA RUKOHVATA 8562 NA STAKLO
PLACEMENT SCHEME OF THE GLASS FINISHING (REF. COR-8561, 8562 AND 8563)

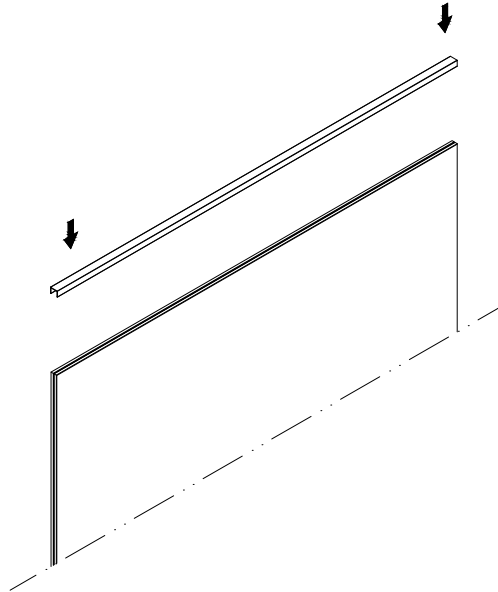

OPCIJA 1: ZATVARANJE SA SAMOLJEPLJIVOM TRAKOM
OPTION 1: SEALING WITH FINISHING ADHESIVE TAPE

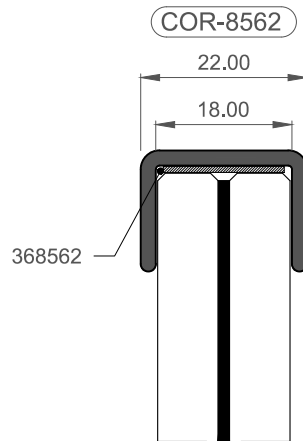

OPCIJA 1: ZATVARANJE SILIKONOM
OPTION 2: SEALING WITH SILICONE

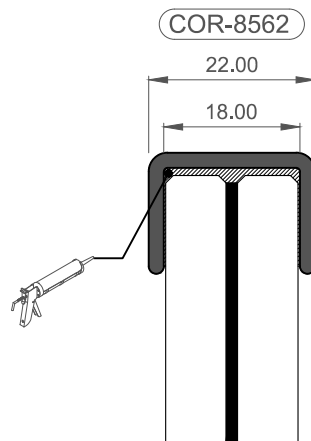

OBRADA PROFILA ZA MONTAŽU OGRADE NA PLOČU

PROFILE COR-8550 MACHINING FOR ASSEMBLY OVER SLAB (VIEW CRYSTAL)

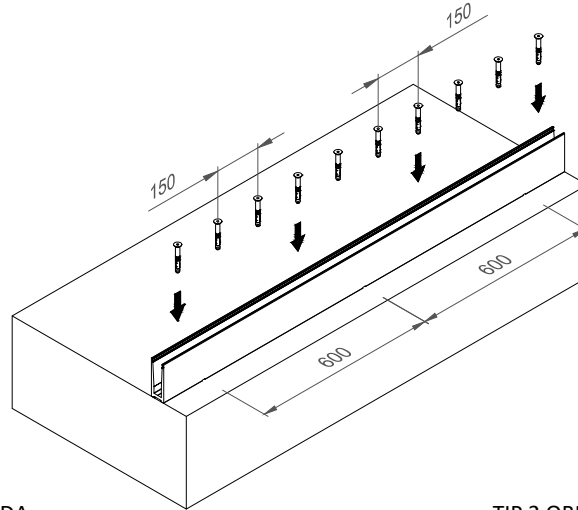

TIP 1 OBRADA
MJESTO ZA ANKERISANJE
RAZMAK: 1 SVAKIH 150 mm
TYPE 1 MACHINING
LODGE FOR ANCHORING
DISTANCE: 1 EVERY 150 mm

TIP 2 OBRADA
DRENAŽNO MJESTO
RAZMAK: SVAKIH 600 mm
TYPE 2 MACHINING
PROFILE DRAINAGE
DISTANCE: 1 EVERY 600 mm

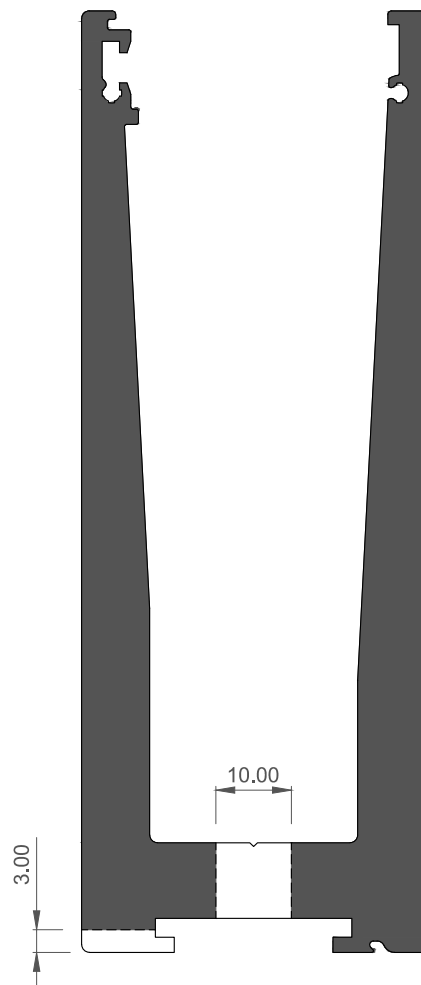
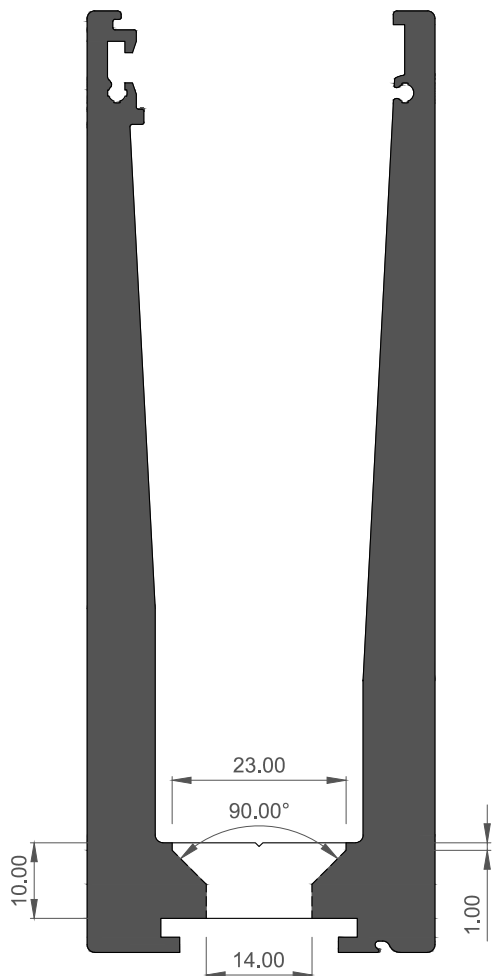

OBRADA PROFILA ZA MONTAŽU OGRADE NA PLOČU SA BOČNE STRANE

PROFILE COR-8550 MACHINING FOR ASSEMBLY ON SLAB INVESTED EDGE (VIEW CRYSTAL PLUS)

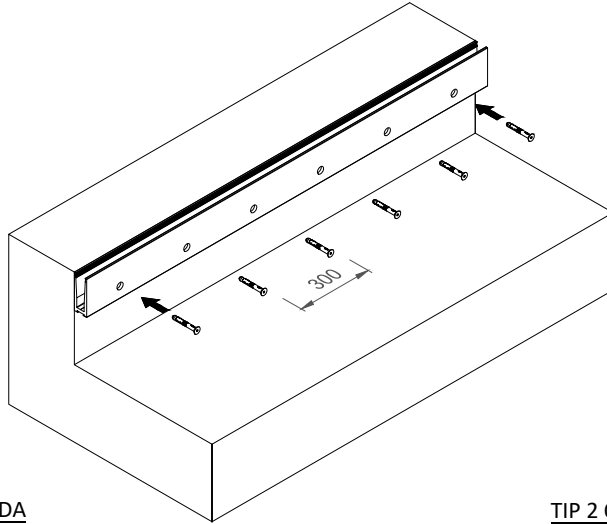

TIP 1 OBRADA
MJESTO ZA ANKERISANJE
RAZMAK: 1 SVAKIH 300 mm
TYPE 1 MACHINING
LODGE FOR ANCHORING
DISTANCE: 1 EVERY 300 mm

TIP 2 OBRADA
DRENAŽNO MJESTO
RAZMAK: SVAKIH 1000 mm
TYPE 2 MACHINING
PROFILE DRAINAGE
DISTANCE: 1 EVERY 1000 mm

